

General	General.....	4
Function	Function.....	7
	PVG 32 valve group	7
	PVPC, plug for external pilot oil supply.....	9
	PVMR, friction detent.....	11
	PVMF, mechanical float position lock	11
	PVBS, main spools for flow or pressure control	12
	PVPX, electrical LS unloading valve.....	13
Technical Data	Technical data.....	14
	PVG 32, valve group.....	14
	PVH, hydraulic actuation.....	14
	PVM, mechanical actuation.....	15
	PVE, electrical actuation	16
	PVE, electrical actuation	17
	PVE oil consumption	18
	PVPX, electrical LS unloading valve	19
Electrical Actuation	Electrical actuation	20
	Function	20
Modules and Code Numbers	Modules and code numbers	26
	PVP, pump side modules	26
	PVPV/PVPVM pump side modules.....	28
	PVB, basic modules – without adjustable LS _{A/B} pressure limiting valves	29
	PVB, basic modules – with adjustable LS _{A/B} pressure limiting valves	30
	PVM, mechanical actuation	31
	PVMD cover for mechanical actuation	31
	PVH, cover for hydraulic actuation.....	31
	PVMR, cover for friction detent	31
	PVMF,cover for mechanical float position.....	31
	PVE, electrical actuation	32
	PVLA, suction valve.....	33
	PVLV, shock and suction valve.....	33
	PVS, end plate.....	34
	PVAS, assembly kit.....	34
	PVPX, electrical LS unloading valve.....	35
	PVPC, plug for external pilot oil supply.....	35
Technical characteristics	Technical characteristics.....	36
	PVP, pump side module	36
	PVB, basic module.....	37
	PVLV, shock and suction valve.....	44
	Pressure control spools	46
	Characteristics for float position main spools.....	47
Dimensions	Dimensions.....	49

© 2009 Sauer-Danfoss. All rights reserved.

Sauer-Danfoss accepts no responsibility for possible errors in catalogs, brochures and other printed material. Sauer-Danfoss reserves the right to alter its products without prior notice. This also applies to products already ordered provided that such alterations can be made without affecting agreed specifications. All trademarks in this material are properties of their respective owners. Sauer-Danfoss, the Sauer-Danfoss logotype, the Sauer-Danfoss S-icon, PLUS+1™, What really matters is inside® and Know-How in Motion™ are trademarks of the Sauer-Danfoss Group.

Frontpage: P301 102, P300 002, P300 010, F301 306, Drawing 157-195. ai

**Contents
 (Continued)**

Lever Positions Lever positions 53

Hydraulic Systems Hydraulic systems 54

Electrical Systems Electrical systems 55

System Safety System safety 57

**Other Operating
 Conditions** Other operating conditions..... 62

Module Selection Chart Module selection chart 64

Order Specification Order specification..... 72

Specification Sheet Specification sheet..... 76

**Specification Sheet,
 SAE Version** Specification sheet, SAE version 77

Rated Pressure

Product	Rated pressure
PVG 32 w. PVS	300 bar [4351 psi]
PVG 32 w. PVS1	350 bar [5076 psi]
PVG 32 w. PVBZ	210 bar [3046 psi]
PVG 32 w. HIC steel	350 bar [5076 psi]
PVG 32 w. HIC aluminium	210 bar [3046 psi]
PVG 120/32 w. PVS	300 bar [4351 psi]
PVG 120/32 w. PVS1	350 bar [5076 psi]
PVG 100/32 w. PVS	300 bar [4351 psi]
PVG 100/32 w. PVS1	350 bar [5076 psi]

General

Valve system

PVG 32 is a hydraulic load sensing valve designed to give maximum flexibility. From a simple load sensing directional valve, to an advanced electrically controlled load-independent proportional valve.



The PVG 32 module system makes it possible to build up a valve group to meet requirements precisely. The compact external dimensions of the valve remain unchanged whatever combination is specified.

General features PVG 32

- Load-independent flow control:
 - Oil flow to an individual function is independent of the load pressure of this function
 - Oil flow to one function is independent of the load pressure of other functions
- Good regulation characteristics
- Energy-saving
- Up to 10 basic modules per valve group
- Several types of connection threads
- Low weight

PVP – pump side module

- Built-in pressure relief valve
- System pressure up to 350 bar [5075 psi]
- Pressure gauge connection
- Versions:
 - Open centre version for systems with fixed displacement pumps
 - Closed centre version for systems with variable displacement pumps
 - Pilot oil supply for electrical actuator built into the pump side module
 - Versions prepared for electrical LS unloading valve PVPX

PVB, basic module

- Interchangeable spools
- Depending on requirements the basic module can be supplied with:
 - Integrated pressure compensator in channel P
 - Check valve in channel P
 - Shock/suction valves
 - LS pressure limiting valves individually adjustable for ports A and B
 - Different spool variants

Actuation modules

The basic module is always fitted with mechanical actuator PVM, which can be combined with the following as required:

- Electrical actuator (11 - 32 V $\overline{\text{---}}$)
 - PVES – proportional, super
 - PVEH – proportional, high performance
 - PVEA - proportional low hysteresis
 - PVEM – proportional, medium performance
 - PVEO – ON/OFF
- PVMD, cover for mechanical actuation
- PVMR, cover for mechanical detent
- PVMF, cover for mechanical float
- PVH, cover for hydraulic actuation

General

Actuation modules

The basic module is always fitted with mechanical actuator PVM, which can be combined with the following as required:

- Electrical actuator (11 - 32 V $\overline{=}$)
 - PVES – proportional, super performance
 - PVEH – proportional, high performance
 - PVEA – proportional, low hysteresis
 - PVEM – proportional, medium performance
 - PVEO – ON/OFF
- PVMD, cover for mechanical actuation
- PVMR, cover for mechanical detent
- PVMF, cover for mechanical float
- PVH, cover for hydraulic actuation

Accessories

Remote control units

- Electrical remote control units
 - PVRE, PVRET
 - PVREL
 - PVRES
 - Prof 1
 - Prof 1 CIP
- Hydraulic remote control unit
 - PVRHH

Electronics

- EHF, flow adjustment unit
- EHR, ramp generator
- EHS, speed control
- EHSC, closed loop speed control
- EHA, alarm logic
- EHC, closed loop position control
- PVG CIP
- CIP Configuration Tool



PVG 32 Proportional Valve
Technical Information
Notes

Notes

**PVG 32 Valve Group with
Open Centre PVP
(PVB with Flow Control
Spool)**

When the pump is started and the main spools in the individual basic modules (11) are in the neutral position, oil flows from the pump, through connection P, across the pressure adjustment spool (6) to tank. The oil flow led across the pressure adjustment spool determines the pump pressure (stand-by pressure).

When one or more of the main spools are actuated, the highest load pressure is fed through the shuttle valve circuit (10) to the spring chamber behind the pressure adjustment spool (6), and completely or partially closes the connection to tank.

Pump pressure is applied to the right-hand side of the pressure adjustment spool (6). The pressure relief valve (1) will open should the load pressure exceed the set value, diverting pump flow back to tank.

In a pressure-compensated basic module the compensator (14) maintains a constant pressure drop across the main spool – both when the load changes and when a module with a higher load pressure is actuated.

With a non pressure-compensated basic module incorporating a load drop check valve (18) in channel P, the check valve prevents return oil flow. The basic module can be supplied without the load drop check valve in channel P for functions with over-centre valves.

The shock valves PVLP (13) with fixed setting and the suction valves PVLA (17) on ports A and B are used for the protection of the individual working function against overload and/or cavitation.

An adjustable LS pressure limiting valve (12) can be built into the A and B ports of pressure-compensated basic modules to limit the pressure from the individual working functions.

The LS pressure limiting valves save energy compared with the shock valves PVLP:

- With PVLP all the oil flow to the working function will be led across the combined shock and suction valves to tank if the pressure exceeds the fixed setting.
- With LS pressure limiting valves an oil flow of about 2 l/min [0.5 US gal/min] will be led across the LS pressure limiting valve to tank if the pressure exceeds the valve setting.

**PVG 32 Valve Group with
Closed Centre PVP
(PVB with Flow Control
Spool)**

In the closed centre version an orifice (5) and a plug (7) have been fitted instead of the plug (4). This means that the pressure adjustment spool (6) will only open to tank when the pressure in channel P exceeds the set value of the pressure relief valve (1).

In load sensing systems the load pressure is led to the pump regulator via the LS connection (8).

In the neutral position the pump control sets the displacement so that leakage in the system is compensated for, to maintain the set stand-by pressure. When a main spool is actuated the pump regulator will adjust the displacement so that the set differential pressure between P and LS is maintained.

The pressure relief valve (1) in PVP should be set at a pressure of approx. 30 bar [435 psi] above maximum system pressure (set on the pump or external pressure relief valve).

**PVG 32
Sectional Drawing**

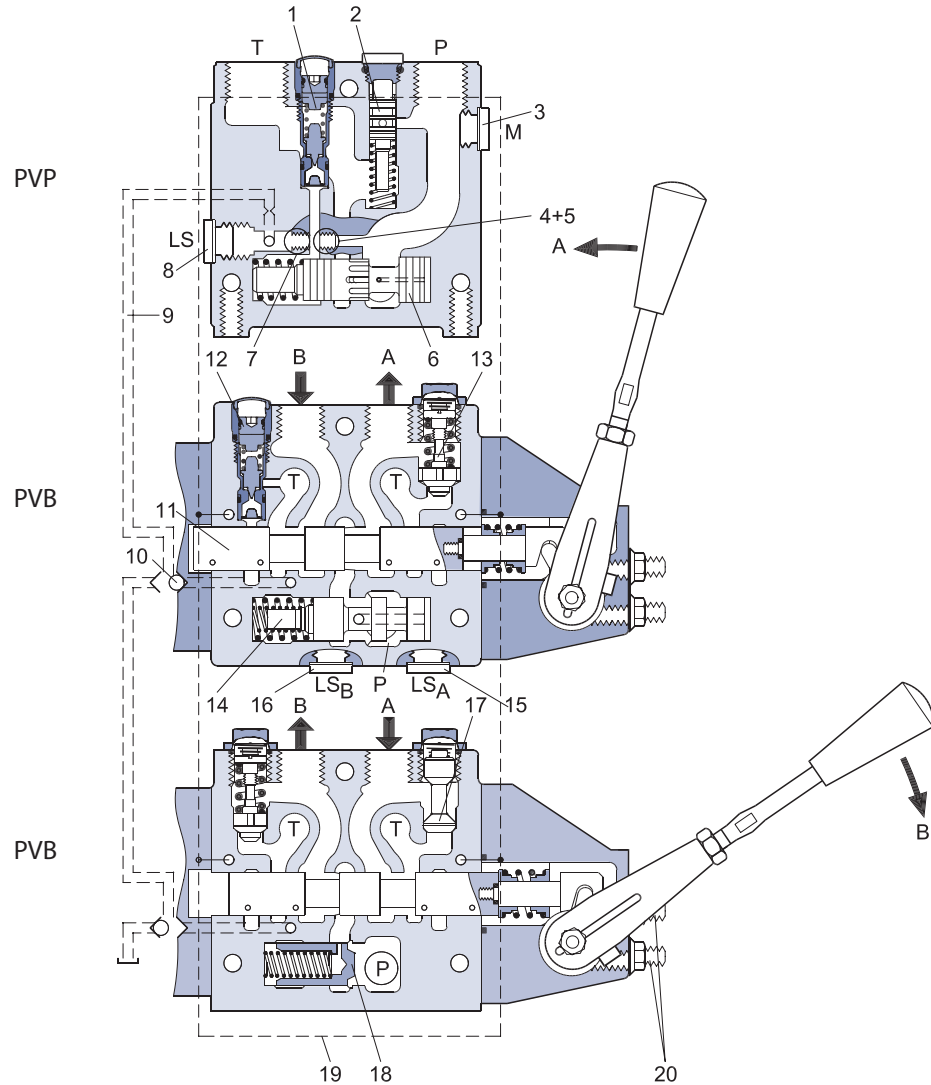

157-104.11

- | | |
|--|---|
| 1. Pressure relief valve | 11. Main spool |
| 2. Pressure reduction valve for pilot oil supply | 12. LS pressure limiting valve |
| 3. Pressure gauge connection | 13. Shock and suction valve, PVLP |
| 4. Plug, open centre | 14. Pressure compensator |
| 5. Orifice, closed centre | 15. LS connection, port A |
| 6. Pressure adjustment spool | 16. LS connection, port B |
| 7. Plug, closed centre | 17. Suction valve, PVLA |
| 8. LS connection | 18. Load drop check valve |
| 9. LS signal | 19. Pilot oil supply for PVE |
| 10. Shuttle valve | 20. Max. oil flow adjustment screws for ports A and B |

**PVPC,
 Plug for External Pilot Oil
 Supply**

PVPC with check valve for open centre PVP

PVPC with check valve is used in systems where it is necessary to operate the PVG 32 valve by means of the electrical remote control without pump flow.

When the external solenoid valve is opened, oil from the pressure side of the cylinder is fed via the PVPC through the pressure reducing valve to act as the pilot supply for the electrical actuators.

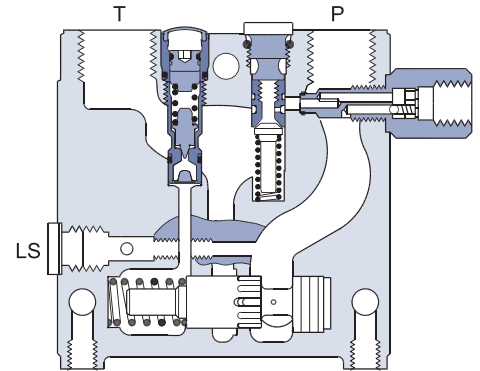

157-114.11

This means that a load can be lowered by means of the remote control lever without starting the pump. The built-in check valve prevents the oil from flowing via the pressure adjustment spool to tank. With the pump functioning normally the external solenoid valve is closed to ensure that the load is not lowered due to the pilot supply oil flow requirement of approximately 1 l/min [0.25 US gal/min].

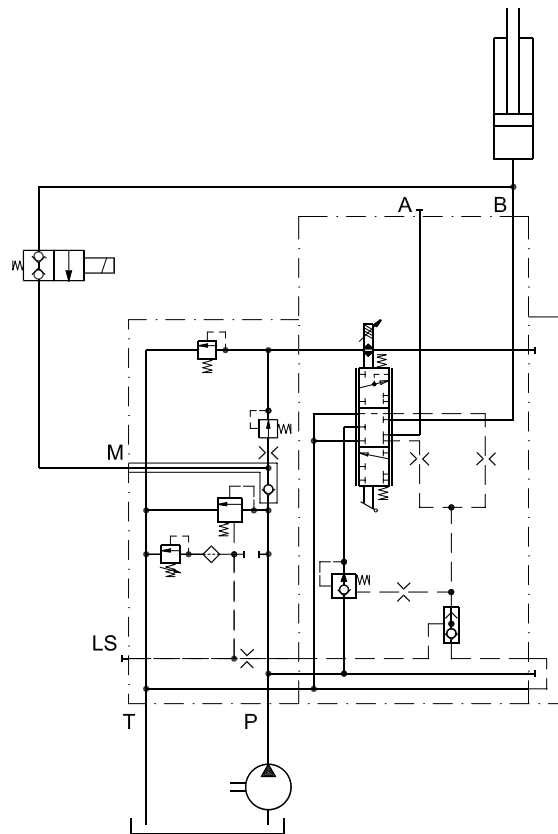

157-116.10

With closed centre PVP the external pilot oil supply can be connected to the pressure gauge connection without the use of a PVPC plug.

**PVPC,
 Plug for External Pilot Oil
 Supply**

**PVPC without check valve
 for open or closed centre PVP**

PVPC without check valve is used in systems where it is necessary to supply the PVG 32 valve with oil from a manually operated emergency pump without directing oil flow to the pilot oil supply (oil consumption about 1 l/min) [0.25 US gal/min].

When the main pump is working normally, the oil is directed through the PVPC plug via the pressure reduction valve to the electrical actuators.

When the main pump flow fails, the external shuttle valve ensures that the oil flow from the manually operated emergency pump is used to pilot open the over centre valve and lower the load. The load can only be lowered using the mechanical operating lever of the PVG 32 valve.

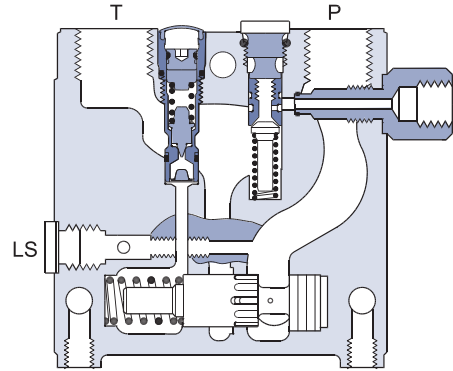

157-193.11

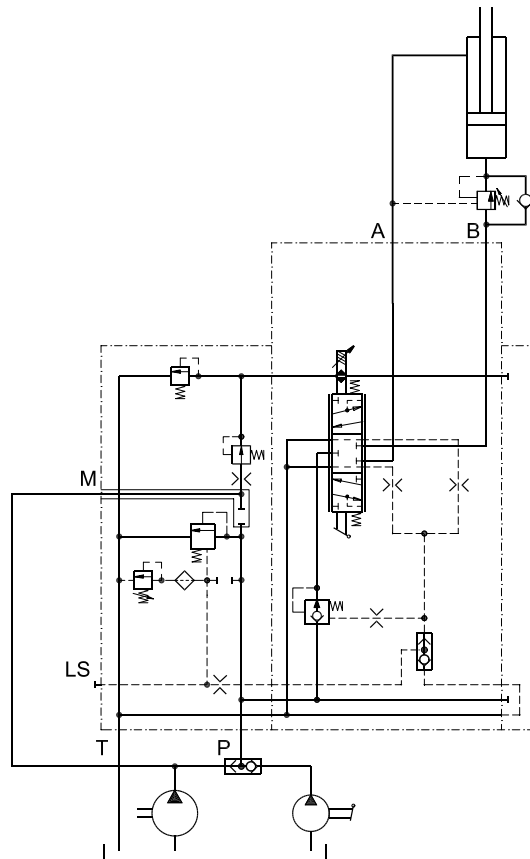

157-194.10

**PVMR,
 Friction Detent**

PVMR, Friction Detent

The friction detent PVMR allows the directional spool to be held in any position, resulting in infinitely variable, reversible, pressure compensated flow. This can be sustained indefinitely with-out having to continue to hold the mechanical lever.

Please note:

PVMR should only be used together with PVB basic modules with pressure compensator.

PVMR

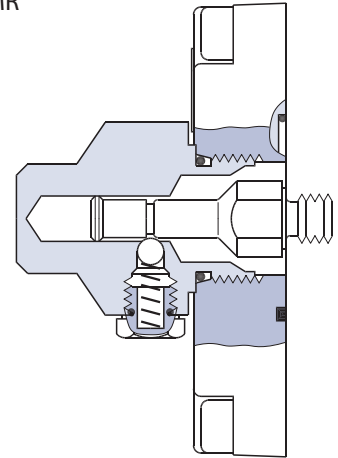

157-204.10

**PVMF,
 Mechanical Float
 Position Lock**

PVMF, Mechanical Float Position Lock

This allows the float spool to be held in the float position after release of the mechanical handle.

PVMF
 P → A → F
 (Standard assembly)

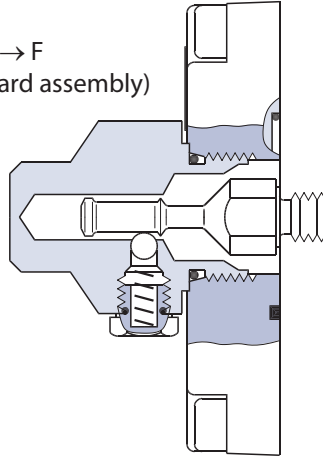

157-205.10

PVMF
 P → B → F
 (Standard assembly)

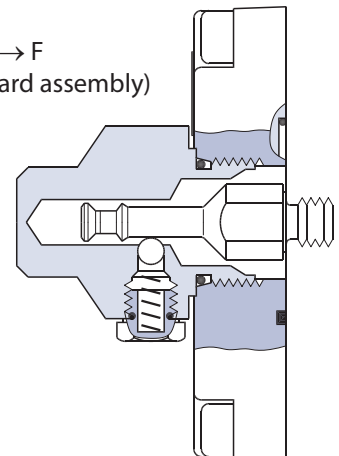

157-206.10

**PVBS,
 Main Spools for Flow
 Control (Standard)**

When using standard flow control spools, the pump pressure is determined by the highest load pressure. This is done either via the pressure adjustment spool in open centre PVP (fixed displacement pumps) or via the pump regulator (variable displacement pumps).

In this way the pump pressure will always correspond to the load pressure plus the stand-by pressure of the pressure adjustment spool or the pump regulator. This will normally give optimum and stable adjustment of the oil flow.

**PVBS,
 Main Spools
 for Flow Control
 (with Linear
 Characteristic)**

PVBS main spools with linear characteristic have less dead band than standard spools and a completely proportional ratio between control signal and oil flow in the range beyond the dead band. PVBS with linear characteristic must never be used together with PVEM electrical actuators. The interaction between the small dead band of the spools and the hysteresis of the PVEM actuator of 20% involves a risk of building up a LS pressure in neutral position.

**PVBS,
 Main Spools for Pressure
 Control**

In a few systems load sensing pump pressure may result in unstable adjustment of the oil flow and a tendency towards system hunting. This may be the case with working functions that have a large moment of inertia or over-centre valves. In such systems main spools for pressure control can be advantageous.

The spools are designed in such a way that the pump pressure is controlled by the spool travel. The main spool must be displaced until the pump pressure just exceeds the load pressure before the working function is applied. If the main spool is held in this position, the pump pressure will remain constant – even if the load pressure changes – giving a stable system.

The use of pressure control spools, however, also means that

- the oil flow is load dependent
- the dead band is load dependent
- the pump pressure can exceed the load pressure by more than is usual.

Due to these factors it is recommended that pressure control spools are only used when it is known for certain that problems with stability will arise – or already have arisen.

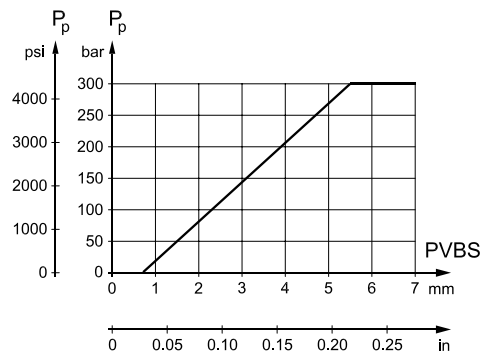

157-156.10

**PVPX,
Electrical LS Unloading
Valve**

PVPX is a solenoid LS unloading valve. PVPX is fitted into the pump side module enabling a connection to be made between the LS and the tank lines. Thus the LS signal can be relieved to tank by means of an electric signal.

For a PVP pump side module in open centre version the relief to tank of the LS signal means that the pressure in the system is reduced to the sum of the tank port pressure plus the neutral flow pressure for the pump side module.

For a PVP pump side module in closed centre version the relief to tank of the LS signal means that the pressure is reduced to the sum of the tank port pressure for the pump side module plus the stand-by pressure of the pump.

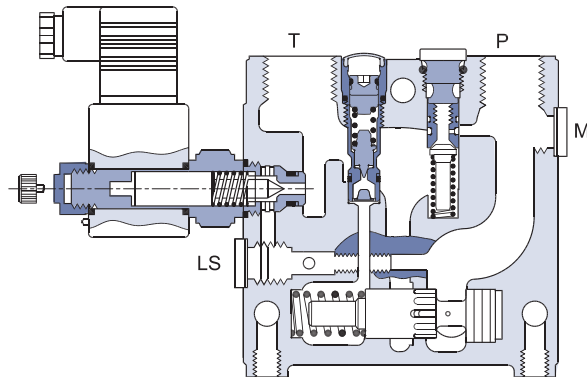

157-195.11

PVG 32
Valve Group

The technical data for PVG 32 and PVPX are typical measured results. For the hydraulic system a mineral based hydraulic oil with a viscosity of 21 mm²/s [102 SUS] and a temperature of 50°C [122°F] was used.

Max. pressure	Port P continuous	350 bar ¹⁾	[5075 psi]
	Port A/B	350 bar	[5075 psi]
	Port T, static/dynamic	25 / 40 bar	[365/580 psi]
Oil flow rated (See characteristics page 31 - 36)	Port P	140/230 l/min ^{3) 4)}	[37/61 US gal/min] ^{3) 4)}
	Port A/B, with press.comp.	100 l/min ²⁾	[26.4 US gal/min] ²⁾
	Port A/B without press.comp.	125 l/min	[33 US gal/min]
Spool travel, standard		± 7 mm	[± 0.28 in]
Spool travel, float position, spool	Proportional range	± 4.8 mm	± 0.19 in]
	Float position	± 8 mm	[± 0.32 in]
Dead band, flow control spools	Standard	± 1.5 mm	[± 0.06 in]
	Linear characteristic	± 0.8 mm	[± 0.03 in]
Max. internal leakage at 100 bar [2175 psi] and 21 mm ² /s [102 SUS]	A/B → T without shock valve λ ε σ	20 cm ³ /min	[1.85 in ³ /min]
	A/B → T with shock valve	25 cm ³ /min	[2.15 in ³ /min]
Oil temperature (inlet temperature)	Recommended temperature	30 → 60 °XC	[86 → 140°F]
	Min. temperature	-30°C	[-22°F]
	Max. temperature	+90°C	[194°F]
Ambient temperature		-30 → 60 °XC	[-22 → 140°F]
Oil viscosity	Operating range	12 - 75 mm ² /s	[65 - 347 SUS]
	Min. viscosity	4 mm ² /s	[39 SUS]
	Max. viscosity	460 mm ² /s	[2128 SUS]
Filtration (See page 55)	Max. contamination (ISO 4406)	23/19/16	23/19/16
Oil consumption in pilot oil pressure reduction valve		1 l/min	[0.25 US gal/min]

- 1) With PVSI end plate. With PVS end plate max. 300 bar [4351 psi].
- 2) For 130 l/min contact technical Sales Organization for Sauer-Danfoss
- 3) In open circuit systems with short P-hoses/tubes, attention should be paid to pressure peaks at flows >100 l/min. [26.4 US gal/min]
- 4) For system with Mid inlet PVPVM, [see page 28](#)

PVH,
Hydraulic Actuation

Regulation range	5 - 15 bar	[75 - 220 psi]
Max. pilot pressure	30 bar	[435 psi]
Max. pressure on port T ¹⁾	10 bar	[145 psi]

- 1) The PVRHH remote control lever should be connected direct to tank.

**PVM,
 Mechanical Actuation**

Regulation range, control lever		± 19.5°	
Regulation range	Proportional range	±13.4°	
	Float position	22.3°	
Operating force	PVM + PVMD	Neutral position	Max. spool travel
		2.2 ± 0.2 N·m [5.0 ± 1.8 lbf·in]	2.8 ± 0.2 N·m [6.3 ± 1.8 lbf·in]
	PVM + PVE 1)	2.2 ± 0.2 N·m [5.0 ± 1.8 lbf·in]	2.8 ± 0.2 N·m [6.3 ± 1.8 lbf·in]
	PVM + PVH	2.7 ± 0.2 N·m [23.9 ± 1.8 lbf·in]	7.1 ± 0.2 N·m [62.8 ± 1.8 lbf·in]
Operating force	PVM + PVMR	Spool displacement from neutral position	17 N·m [3.8 lbf·in]
		Spool displacement from any other position	8.5 N·m [73.3 lbf·in]
	PVM+PVMF	Spool displacement from neutral position	22 N·m [5.0 lbf·in]
		Spool displacement into float position	60 N·m [13.5 lbf·in]
	Spool displacement away from float position	28 N·m [6.3 lbf·in]	
Control lever positions, see page 51		No	2 × 6

1) PVE without voltage

PVE
Technical Data

The following technical data are from typical test results. For the hydraulic system a mineral based hydraulic oil with a viscosity of 21 mm²/s [102 SUS] and a temperature of 50° C [122° F] were used.

PVEO and PVEM

		PVEO and PVEM	
Supply voltage U _{DC}	rated	12 V DC	24 V DC
	range	11 V to 15 V	22 V to 30 V
	max. ripple	5%	
Current consumption at rated voltage		0.65 A @ 12 V	0.33 A @ 24 V
Signal voltage (PVEM)	neutral	0.5 x U _{DC}	
	A-port ↔ B-port	0.25 • U _{DC} to 0.75 • U _{DC}	
Signal current at rated voltage (PVEM)		0.25 mA	0.50 mA
Input impedance in relation to 0.5 • U _{DC}		12 KΩ	
Power consumption		8 W	

Reaction time PVEO and PVEM

Supply voltage	Function		PVEO ON/OFF s	PVEO-R ON/OFF s	PVEM Prop. medium s
Disconnected by means of neutral switch	Reaction time from neutral position to max. spool travel	max.	0.235	0.410	0.700
		rated	0.180	0.350	0.450
		min.	0.120	0.250	0.230
Disconnected by means of neutral switch	Reaction time from max. spool travel to neutral position	max.	0.175	0.330	0.175
		rated	0.090	0.270	0.090
		min.	0.065	0.250	0.065
Constant voltage	Reaction time from neutral position to max. spool position	max.	-	-	0.700
		rated	-	-	0.450
		min.	-	-	0.230
Constant voltage	Reaction time from max. spool travel to neutral position	max.	-	-	0.700
		rated	-	-	0.450
		min.	-	-	0.230
Hysteresis ¹⁾		rated	-	-	20%

¹⁾Hysteresis is indicated at rated voltage and f = 0.02 Hz for one cycle (one cycle = neutral -> full A -> full B -> neutral).

PVE
Technical Data
(Continued)

PVEA, PVEH and PVES

		PVEA, PVEH and PVES		
Supply voltage U_{DC}	rated	11 V to 32 V		
	range	11 V to 32 V		
	max. ripple	5%		
Current consumption at rated voltage	PVEH/PVES (PVEA)	0.57 (0.33) A @ 12 V	0.3 (0.17) A @ 24 V	
Signal voltage	neutral	0.5 x U_{DC}		
	A-port ↔ B-port	0.25 • U_{DC} to 0.75 • U_{DC}		
Signal current at rated voltage		0.25 mA to 0.70 mA		
Input impedance in relation to 0.5 • U_{DC}		12 K Ω		
Input capacitor		100 η F		
Power consumption	PVEH/PVES (PVEA)	7 (3.5) W		
(PVEH/PVES)	Active	Max. load	100 mA	60 mA
		Reaction time at fault	500 ms (PVEA: 750 ms)	
	Passive	Reaction time at fault	250 ms (PVEA: 750 ms)	

Reaction time

Supply voltage	Function		PVEA	PVEH	PVES
			Prop. fine s	Prop. high s	Prop. super s
Disconnected by means of neutral switch	Reaction time from neutral position to max. spool travel	max.	0.500	0.230	0.230
		rated	0.320	0.150	0.150
		min.	0.250	0.120	0.120
Disconnected by means of neutral switch	Reaction time from max. spool travel to neutral position	max.	0.550	0.175	0.175
		rated	0.400	0.090	0.090
		min.	0.300	0.065	0.065
Constant voltage	Reaction time from neutral position to max. spool travel	max.	0.500	0.200	0.200
		rated	0.320	0.120	0.120
		min.	0.250	0.050	0.050
Constant voltage	Reaction time from max. spool travel to neutral position	max.	0.250	0.100	0.100
		rated	0.200	0.090	0.090
		min.	0.150	0.065	0.065

Hysteresis ¹⁾	rated	2%	4%	~ 0%
--------------------------	-------	----	----	------

¹⁾ Hysteresis is indicated at rated voltage and $f = 0.02$ Hz for one cycle (one cycle = neutral -> full A -> full B -> neutral).

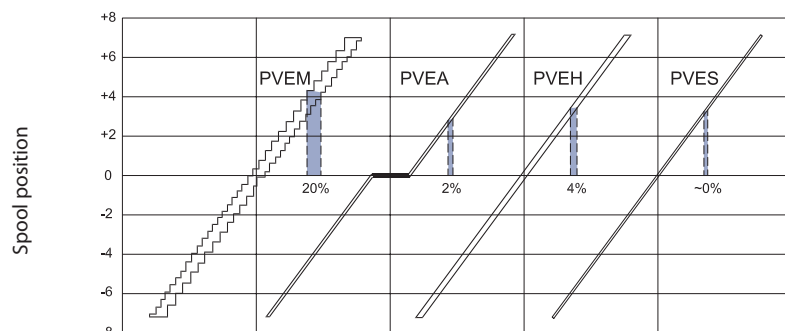

157-504.10

**Technical Data
 (Continued)**

Oil consumption PVEO and PVEM

Supply voltage	Function	PVEO ON/OFF	PVEM Prop. medium
Without voltage	Pilot oil flow per PVE neutral	0 l/min [0 US gal/min]	0 l/min [0 US gal/min]
With voltage	locked	0.1 l/min [0.026 US gal/min]	0.1 l/min [0.026 US gal/min]
	one actuation (neutral → max.)	0.002 l [0.053 US gal]	0.002 l [0.053 US gal]
	continuous actuations (neutral → max.)	0.7 l/min [0.185 US gal/min]	0.5 l/min [0.132 US gal/min]

Oil consumption PVEA, PVEH and PVES

Supply voltage	Function	PVEA Prop. fine	PVEH Prop. high	PVES Prop. super
Without voltage	Pilot oil flow per PVE neutral	0 l/min [0 US gal/min]	0 l/min [0 US gal/min]	0.3 l/min [0.106 US gal/min]
With voltage	locked	0.4 l/min [0.132 US gal/min]	0.1 l/min [0.026 US gal/min]	0.1 l/min [0.053 US gal/min]
	one actuation (neutral → max.)	0.002 l [0.053 US gal]	0.002 l [0.053 US gal]	0.002 l [0.053 US gal]
	continuous actuations	1.0 l/min [0.200 US gal/min]	0.7 l/min [0.290 US gal/min]	0.8 l/min [0.290 US gal/min]

Oil viscosity

Oil viscosity	range	12 - 75 mm ² /s [65 - 347 SUS]
	min.	4 mm ² /s [39 SUS]
	max.	460 mm ² /s [2128 SUS]

Oil temperature

Oil temperature	Rec. range	30 - 60°C [86 - 140°F]
	min.	-30°C [-22°F]
	max.	90°C [194°F]

Note: Max. start up viscosity 2500 mm²/s

Filtering

Filtering in the hydraulic system	Max. allowed degree of contamination (ISO 4406, 1999 version): 23/19/16
-----------------------------------	---

Ambient temperature

Ambient temperature range Rec.	-30° → +60°C [-22° → +140°F]
--------------------------------	------------------------------

**PVPX,
 Electrical LS
 Unloading Valve**

Max. operating pressure		350 bar [5075 psi]	
Enclosure to IEC 529		IP65	
Max. pressure drop at an oil flow of 0.10 l/min. [2.6 US gal/min]		2 bar [30 psi]	
Oil temperature (inlet temperature)	Recommended temperature	30 to 60°C [86 to 140°F]	
	Min. temperature	-30°C [-22°F]	
	Max. temperature	90°C [194°F]	
Max. coil surface temperature		155°C [311°F]	
Ambient temperature		-30 to 60°C [-22 to 140°F]	
Oil viscosity	Operating range	12 to 75 mm ² /s [65 to 347 SUS]	
	Min. viscosity	4 mm ² /s [39 SUS]	
	Max. viscosity	460 mm ² /s [2128 SUS]	
Response time for LS pressure relief		300 ms	
Rated voltage		12 V	24 V
Max. permissible deviation from rated supply voltage		± 10%	
Current consumption at rated voltage	at 22°C [72°F] coil temperature	1.55 A	0.78 A
	at 110°C [230°F] coil temperature	1.00 A	0.50 A
Power consumption	at 22°C [72°F] coil temperature	19 W	19 W
	at 110°C [230°F] coil temperature	12 W	12 W

Function

The philosophy of Sauer-Danfoss electro hydraulic actuation, type PVE, is integration of electronics, sensors and actuators into a single unit that interfaces directly to the proportional valve body.

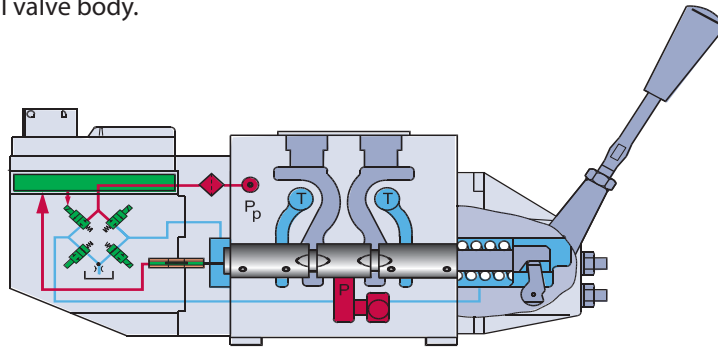

157-497

Closed loop control

All the proportional actuators feature an integrated feedback transducer that measures spool movement in relation to the input signal, and by means of a solenoid valve bridge, controls the direction, velocity and position of the main spool of the valve. The integrated electronics compensate for flow forces on the spool, internal leakage, changes in oil viscosity, pilot pressure, etc. This results in lower hysteresis and better resolution. Furthermore the electronics enable built in safety like fault monitoring, directional indication and LED light indication.

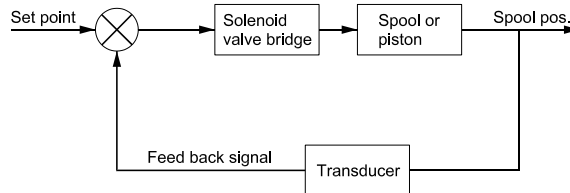

157-503.10

Principle

In principle the input signal (set-point signal) determines the level of pilot pressure which moves the main spool. The position of the main spool is sensed in the LVDT transducer which generates an electric feed-back signal registered by the electronics. The variation between the set-point signal and feed-back signal actuates the solenoid valves. The solenoid valves are actuated so that hydraulic pilot pressure drives the main spool into the correct position.

Inductive transducer, LVDT

(Linear Variable Differential Transformer). When the main spool is moved, a voltage is induced proportional to the spool position. The use of LVDT gives contact-free monitoring of the main spool position. This means an extra-long working life and no limitation as regards the type of hydraulic fluid used. In addition, LVDT gives a precise position signal of high resolution.

Integrated pulse width modulation

Positioning of the main spool in PVEA/PVEH/PVES is based on the pulse width modulation principle. As soon as the main spool reaches the required position, modulation stops and the spool is locked in position.

ON/Off Actuation

With electrical ON/OFF actuation the main spool is moved from neutral to maximum stroke when power is connected.

PVEO, ON/OFF

Main features of PVEO:

- Compact
- Robust operation
- With Hirschmann or AMP connector
- Low electrical power

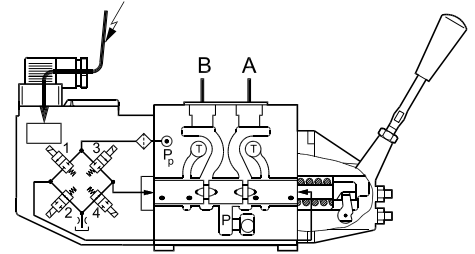

157-99.11

PVEO-R, ON/OFF with hydraulic ramp

Like PVEO, but for applications where longer reaction time is needed.

Proportional Actuation

With electrical proportional actuation the main spool position is adjusted so that it corresponds to an electrical signal – e.g. from a remote control unit.

PVEM, proportional medium

PVEM versions are recommended where there is a requirement for medium resolution proportional control and where reaction and hysteresis are not critical.

Main features of PVEM:

- ON-OFF modulated
- Inductive transducer
- Medium hysteresis
- With Hirschmann connector only
- Low electrical power
- No set-up procedure

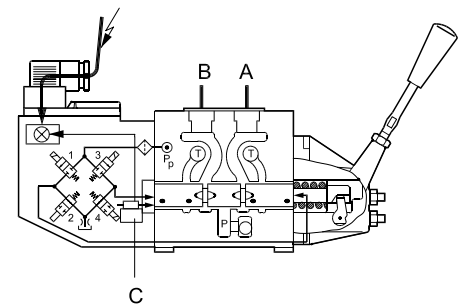

157-49.11

PVEA, proportional fine

PVEA versions are recommended where among the requirements are fault monitoring, low hysteresis, high resolution but where the reaction time is not critical.

Main features of PVEA:

- Inductive transducer
- Integrated pulse width modulation
- AMP connector only
- As option with directional indicator (DI)
- Fault monitoring with transistor output for signal source.
- Low electrical power
- No set-up procedure

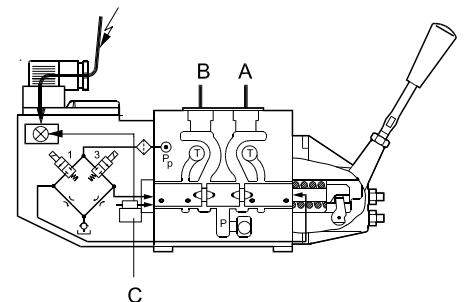

157-654.10

Proportional Actuation (Continued)

PVEH, proportional high

Performance like PVEA but with fast reaction time.

Main features of PVEH:

- Inductive transducer
- Integrated pulse width modulation
- Low hysteresis
- Fast reaction time
- Hirschmann or AMP connector
- As option with directional indicator (DI)
- Fault monitoring with transistor output for signal source
- Low electrical power
- No set-up procedure

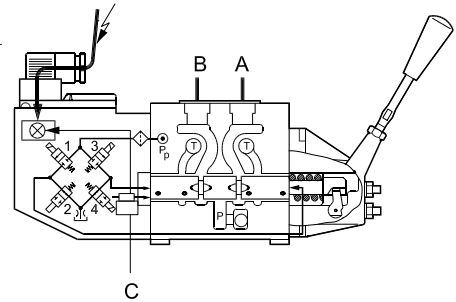

157-48.11

PVES, proportional super

PVES versions are recommended for control systems requiring very low hysteresis to obtain a high resolution.

For other technical data: see PVEH

- Hirschmann or AMP connector

The Fault Monitoring System

A fault monitoring system is provided in all PVEA, PVEH and PVES modules. The system is available in two versions:

- The active fault monitoring type, which provides a warning signal, deactivates the solenoid valves and drives the spool in neutral.
- The passive fault monitoring type, which provides a warning signal only.

Both active and passive fault monitoring systems are triggered by three main events:

1. Input signal monitoring

The input signal voltage is continuously monitored. The permissible range is between 15% and 85% of the supply voltage. Outside this range the section will switch into an active error state.

2. Transducer supervision

If one of the wires to the LVDT sensor is broken or short-circuited, the section will switch into an active error state.

3. Supervision of the closed loop

The actual position must always correspond to the demanded position (input signal). If the actual spool position is further than the demanded spool position (>12%, PVEA: >25%), the system detects an error and will switch into an active error state. On the other hand, a situation where the actual position is closer to neutral than that demanded will not cause an error state. This situation is considered "in control". When an active error state occurs, the fault monitoring logic will be triggered:

Active fault monitoring

- A delay of 500 ms (PVEA: 750 ms) before anything happens.
- The solenoid valve bridge will be disabled and all solenoid valves will be released.
- An alarm signal is sent out through the appropriate pin connection.
- This state is memorized and continues until the system is actively reset (by turning off the supply voltage).

Passive fault monitoring

- A delay of 250 ms (PVEA: 750 ms) before anything happens.
- The solenoid valve bridge will not be disabled but still control the main spool position.
- An alarm signal is sent out through the appropriate pin connection.
- This state is not memorized. When the erroneous state disappears, the alarm signal will turn to passive again. However, the signal will always be active for a minimum of 100 ms when triggered.

To prevent the electronics from going into an undefined state, a general supervision of the power supply and the internal clock frequency is made. This function applies to PVEA, PVEH and PVES - and will not activate fault monitoring:

1. High supply voltage

The solenoid valves are disabled when the supply voltage exceeds 36 V, and the main spool will return/stay in neutral.

2. Low supply voltage:

The solenoid valves are disabled when the supply voltage falls below 8.5 V, and the main spool will return/stay in neutral.

The Fault Monitoring System (Continued)

3. Internal clock

The solenoid valves are disabled when the internal clock frequency fails, and the main spool will return/stay in neutral.

⚠ WARNING

It's up to the customer to decide on the required degree of safety for the system (see PVE series 4 catalogue DKMH.PK.570.A1.02, page 19).

Note:

1. Different degrees of safety are described on pages 56 to 59.
2. The fault monitoring does not work if the supply voltage to PVEA/PVEH/PVES is cut off – for example by a neutral position switch (see page 56).
3. When using PVEA/PVEH/PVES with passive fault monitoring it's up to the customer to decide on the required degree of safety for the system (see page 56).

Fault Monitoring Specification

Type	Fault monitoring	Delay before error out	Error mode	Error output status	Fault output on PVE ¹⁾	LED light	Memory (reset needed)
PVEO PVEM	No fault monitoring	-	-	-	-	-	-
PVEA PVEH PVES	Active	500 ms (PVEA: 750ms)	No fault	Low	< 2 V	Green	-
			Input signal faults	High	~U _{DC}	Flashing red	Yes
			Transducer (LVDT)			Constant red	
	Close loop fault						
	Passive	250 ms (PVEA: 750ms)	No fault	Low	< 2 V	Green	-
			Input signal faults	High	~U _{DC}	Flashing red	No
Transducer (LVDT)			Constant red				
Close loop fault							

¹⁾ Measured between fault output pin and ground

**PVEA/PVEH/PVES,
 Connection to Fault
 Monitoring Output**

Normal

Green

Transistor output function

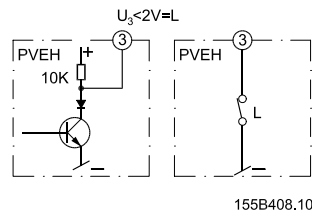

Example of connected components

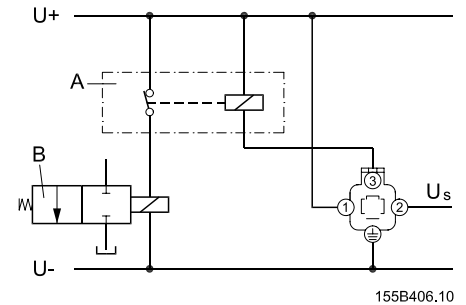

A: External relay
 B: Solenoid valve (e.g. PVPX)

Fault

Red

Transistor output function

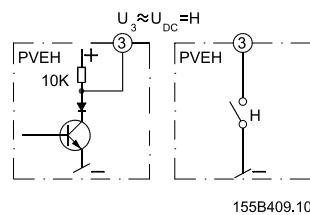

Example of connected components

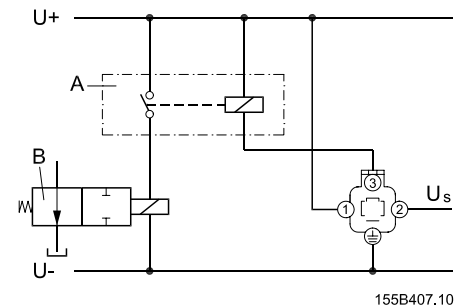

A: External relay
 B: Solenoid valve (e.g. PVPX)

Via an external relay the pin pos. 3 can be connected to a solenoid valve which will relieve the LS-signal to tank, e.g. PVPX.

Other connections possible:

- a solenoid valve to relieve the pump oil flow
- a signal lamp, an alarm horn
- pump cut-out, etc.

PVP, Pump Side Modul

Symbol	Description	Code number
<p>157-24.10</p>	Open centre pump side module for pumps with fixed displacement.	P = G 1/2 T = G 3/4 157B5000
	For purely mechanically actuated valve groups	P = 7/8 in - 14 T = 1 1/16 in - 12 157B5200
		P = G 3/4 157B5100
		P = 1 1/16 in - 12 157B5300
<p>157-23.10</p>	Closed centre pump side module for pumps with variable displacement.	P = G 1/2 T = G 3/4 157B5001
	For purely mechanically actuated valve groups	= 7/8 in - 14 T = 1 1/16 in - 12 157B5201
		P = G 3/4 157B5101
		P = 1 1/16 in - 12 157B5301
<p>157-22.10</p>	Open centre pump side module for pumps with fixed displacement.	P = G 1/2 T = G 3/4 157B5010
	With pilot oil supply for electrically actuated valves	P = 7/8 in - 14 T = 1 1/16 in - 12 157B5210
		P = G 3/4 157B5110
		P = 1 1/16 in - 12 157B5310
<p>157-21.10</p>	Closed centre pump side module for pumps with variable displacement.	P = G 1/2 T = G 3/4 157B5011
	With pilot oil supply for electrically actuated valves	P = 7/8 in - 14 T = 1 1/16 in - 12 157B5211
		P = G 3/4 157B5111
		P = 1 1/16 in - 12 157B5311
<p>157-153.11</p>	Open centre pump side module for pumps with fixed displacement.	P = G 1/2 T = G 3/4 157B5012
	With pilot oil supply for electrically actuated valves	P = 7/8 in - 14 T = 1 1/16 in - 12 157B5212
		P = G 3/4 157B5112
		P = 1 1/16 in - 12 157B5312
<p>157-154.10</p>	Closed centre pump side module for pumps with variable displacement	P = G 1/2 T = G 3/4 157B5013
	With pilot oil supply	P = 7/8 in - 14 T = 1 1/16 in - 12 157B5213
		P = G 3/4 157B5113
		P = 1 1/16 in - 12 157B5313

Connection: P = G 1/2; 14 mm deep or G 3/4; 16 mm deep. LS/M = G 1/4; 12 mm deep; T = G 3/4; 16 mm deep.

P = 7/8 in - 14; 0.65 in deep or 1 1/16 in - 12; 0.75 in deep. LS/M = 1/2 in - 20; 0.47 in deep. T = 1 1/16 in - 12; 0.75 in deep.

PVP, Pump side Moduls

Symbol	Description	Code number
<p>157-294.10</p>	<p>Open centre pump side module for pumps with fixed displacement.</p> <p>For mechanical actuated valves.</p> <p>Connection for LS unloading valve, PVPX</p>	<p>P = G $\frac{3}{4}$ T = G $\frac{3}{4}$</p> <p>157B5102</p>
<p>157-295.10</p>	<p>Closed centre pump side module for pumps with variable displacement.</p> <p>For mechanical actuated valves.</p> <p>Connection for LS unloading valve, PVPX</p>	<p>P = G $\frac{3}{4}$ T = G $\frac{3}{4}$</p> <p>157B5103</p>
<p>157-243.11</p>	<p>Open centre pump side module for pumps with fixed displacement.</p> <p>With pilot oil supply for electrical actuation and connection for pilot oil pressure</p>	<p>P = G $\frac{3}{4}$ T = G $\frac{3}{4}$</p> <p>P = 1 1/16 in - 12 T = 1 1/16 in - 12</p> <p>157B5180</p> <p>157B5380</p>
<p>157-523.10</p>	<p>Closed centre pump side module pumps with variable displacement.</p> <p>With pilot oil supply for electrical actuation and connection for pilot oil pressure</p>	<p>P = G $\frac{3}{4}$ T = G $\frac{3}{4}$</p> <p>P = 1 1/16 in - 12 T = 1 1/16 in - 12</p> <p>157B5181</p> <p>157B5381</p>
<p>157-244.10</p>	<p>Open centre pump side module for pumps with fixed displacement.</p> <p>With pilot oil supply for hydraulic actuation and connection for pilot oil pressure</p>	<p>P = G $\frac{3}{4}$ T = G $\frac{3}{4}$</p> <p>P = 1 1/16 in - 12 T = 1 1/16 in - 12</p> <p>157B5190</p> <p>157B5390</p>
<p>157-245.10</p>	<p>Closed centre pump side module pumps with variable displacement</p> <p>With pilot oil supply for hydraulic actuation and connection for pilot oil pressure</p>	<p>P = G $\frac{3}{4}$ T = G $\frac{3}{4}$</p> <p>P = 1 1/16 in - 12 T = 1 1/16 in - 12</p> <p>157B5191</p> <p>157B5391</p>

Connection: P = G $\frac{1}{2}$; 14 mm deep or G $\frac{3}{4}$; 16 mm deep. LS/M = G $\frac{1}{4}$; 12 mm deep; T = G $\frac{3}{4}$; 16 mm deep.

P = $\frac{7}{8}$ in - 14; 0.65 in deep or 1 $\frac{1}{16}$ in - 12; 0.75 in deep. LS/M = $\frac{1}{2}$ in - 20; 0.47 in deep. T = 1 $\frac{1}{16}$ in - 12; 0.75 in deep.

PVPV and PVPVM, Pump Side Modules

Symbol	Description	Code number
<p>157-315.10</p>	<p>PVPV Closed center pump side module for pumps with variable displacement.</p> <p>With pilot supply for electrical actuation</p> <p>Max. pump pressure = 350 bar [5075 psi] Max. pump flow = 150 l/min [40 US gal/min]</p>	<p>P and T = G1 P and T = 1 5/16 UN</p>
<p>157-329.10</p>	<p>PVPV Closed center pump side module for pumps with variable displacement.</p> <p>With pilot supply for electrical actuation With facility for shock and suction valve PVL63</p> <p>Max. pump pressure = 350 bar [5075 psi] Max. pump flow = 150 l/min [40 US gal/min]</p>	<p>P and T = G1 P and T 1 5/16 UN</p>
<p>157-316.10</p>	<p>PVPVM Closed center pump side module for pumps with variable displacement.</p> <p>With pilot supply for electrical actuation</p> <p>Max. pump pressure = 350 bar [5075 psi] Max. pump flow = 230 l/min [61 US gal/min]</p>	<p>P and T = G1 P and T 1 5/16 UN</p>
<p>157-330.10</p>	<p>PVPVM Closed center pump side module for pumps with variable displacement.</p> <p>With pilot supply for electrical actuation With facility for shock and suction valve PVL63</p> <p>Max. pump pressure = 350 bar [5075 psi] Max. pump flow = 230 l/min [61 US gal/min]</p>	<p>P and T = G1 P and T 1 5/16 UN</p>

MA og LS : G¼ [9/16 - 18 UNF]

PVB, Basic Modules – Without Adjustable $LS_{A/B}$ Pressure Limiting Valves

Symbol	Description	Code number	
		No facilities for shock valves A/B	Facilities for shock valves A/B
<p>157-19.10</p>	Without load drop check valve and pressure compensator Can be used where load holding valves prevent oil from flowing back through channel P. G 1/2 14 mm deep	157B6000	157B6030
	7/8 in -14 0.65 in deep	157B6400	157B6430
<p>157-20.10</p>	Load drop check valve G 1/2 14 mm deep	157B6100	157B6130
	7/8 in -14 0.65 in deep	157B6500	157B6530
<p>157-196.10</p>	Load drop check valve. $LS_{A/B}$ shuttle valve. To be used with float position spools. G 1/2 14 mm deep	-	157B6136
	7/8 in -14 0.65 in deep	-	157B6536
<p>157-197.10</p>	With non-damped compensator valve G 1/2 14 mm deep	157B6200	157B6230
	7/8 in -14 0.65 in deep	157B6600	157B6630

PVB, Basic Modules - Without Adjustable LS_{a/b} Pressure Limiting Valves

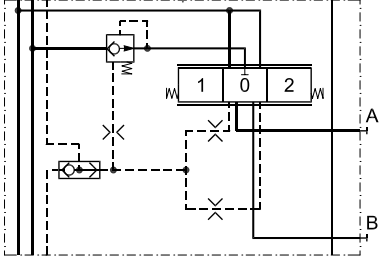
Symbol	Description	Code number	
		No facilities for shock valves A/B	Facilities for shock valves A/B
 <p>157-16.10</p>	G 1/2 14 mm deep With damped compensator valve	157B6206	157B6236
	7/8 in -14 0.65 in deep	-	-

PVB, Basic Modules - With Adjustable LS_{a/b} Pressure Limiting Valves

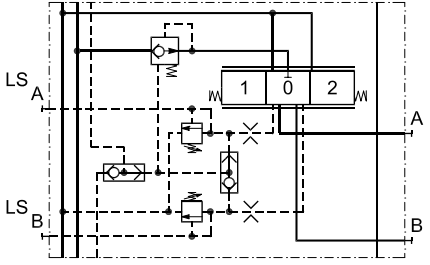
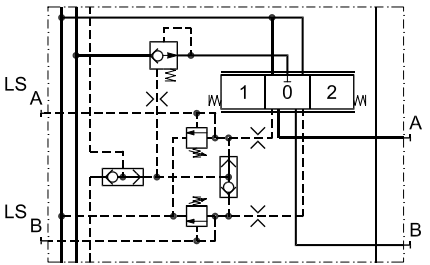
Symbol	Description	Code number	
		No facilities for shock valves A/B	Facilities for shock valves A/B
 <p>157-198.10</p>	With non-damped compensator valve. Adjustable LSA/B pressure limiting valves External LS connection port A/B. Also used for float position spools. G 1/2 14 mm deep	157B6203	157B6233
	7/8 in -14 0.65 in deep	157B6603	157B6633
 <p>157-17.10</p>	Damped compensator valve. Adjustable LSA/B pressure limiting valves External LS connection port A/B	157B6208	157B6238
	7/8 in -14 0.65 in deep	-	-

PVM, Mechanical Actuation

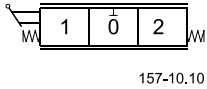
Symbol	Description	Code number		
		with stop screws	w/o stop screws	
	PVM, Standard, spring centered	22.5°	157B3171	157B3191
	Individual oil flow adjustment to ports A and B	37.5°	157B3172	157B3192
	Without actuation lever and base. Shaft for mounting of actuation lever		157B3173	157B3193
	PVM, as standard, without actuation lever.	22.5°	157B3175	157B3195
	With base for mounting of actuation lever	37.5°	157B3174	157B3194
	PVM, Standard, spring. Individual oil flow adjustment to ports A and B. (Anodized)	22.5°	157B3184	-

PVMD, Cover for Mechanical Actuation

Symbol	Description	Code number
	PVMD, Cover for purely mechanically operated valve	157B0001

PVH, Hydraulic Actuation

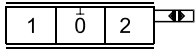
Symbol	Description	Code number
	PVH, Cover for hydraulic remote control	157B0008
		G 1/4, 12 mm deep 9/16 - 18 UNF; 0.54 in deep

PVMR, Friction Detent

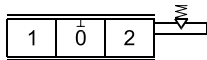
Symbol	Description	Code number
	PVMR, Friction detent	157B0004

PVMF, Mechanical Float Position

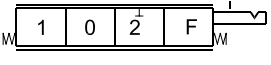
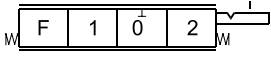
Symbol	Description	Code number
	PVMF Mechanical float position lock	157B0005
		

**Code Numbers for
 Use on PVG 32
 157B....**

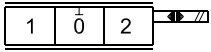

157-36.10

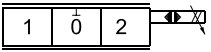

157-35.10

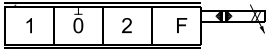

157-189.10

PVE for PVG 32

PVEO, ON/OFF actuation Code no. 157B....		Hirschmann connector		AMP connector		Deutsch connector	
		12 V	24 V	12 V	24 V	12 V	24 V
PVEO	ON/OFF	4216	4228	4901	4902	4291	4292
	ON/OFF with ramp	4217	4229	4903	4904	-	-
	ON/OFF anodized	4266	4268	not available	4272	-	-

PVEM, proportional actuation Code no. 157B....		Hirschmann connector	
		12 V	24 V
PVEM	Standard	4116	4128
	Float -> B	4416	4428

PVEA/PVEH/PVES, proportional actuation Code no. 157B....		Hirschmann connector 11 - 32 V	AMP connector 11 - 32 V	Deutsch connector 11 - 32 V
PVEA	Standard, active fault monitoring	Not available	4734	4792
	Standard, passive fault monitoring	Not available	4735, 4775*	Not available
PVEA-DI	Standard, active fault monitoring	Not available	4736	4796
	Standard, passive fault monitoring	Not available	4737	Not available
PVEH	Standard, active fault monitoring	4032	4034, 4074*	4092
	Standard, passive fault monitoring	4033, 4073*	4035, 4075*	4093
	Float -> B, active fault monitoring	4332	Not available	4392
	Float -> A, active fault monitoring	Not available	4338	Not available
PVEH-DI	Standard, active fault monitoring	Not available	4036	4096
	Standard, passive fault monitoring	Not available	4037	Not available
PVES	0% hysteresis, active fault monitoring	4832	4834	4892
	0% hysteresis, passive fault monitoring	4833	4835, 4865*	Not available

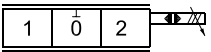

157-655.10

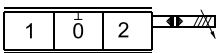

157-34.10

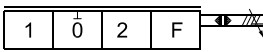

157-190.10

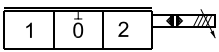

157-34.10





PVLA, Suction Valve (fitted in PVB)

Symbol	Description	Code number
<p>157-15.10</p>	Suction valve for port A and/or B.	157B2001
<p>157-223.10</p>	Plug for connecting the nonactive port to tank, when using a single acting spool.	157B2002

PVLP, Shock and Suction Valve (Fitted in PVB)

Symbol	Description	Setting		Code number
		bar	[psi]	
<p>157-18.10</p>	Shock and suction valve for port A and/or B. (Not adjustable)	32	460	157B2032
		50	725	157B2050
		63	914	157B2063
		80	1160	157B2080
		100	1450	157B2100
		125	1813	157B2125
		140	2031	157B2140
		150	2175	157B2150
		160	2320	157B2160
		175	2538	157B2175
		190	2755	157B2190
		210	3045	157B2210
		230	3335	157B2230
		240	3480	157B2240
		250	3625	157B2250
		265	3843	157B2265
280	4061	157B2280		
300	4351	157B2300		
320	4641	157B2320		
350	5075	157B2350		

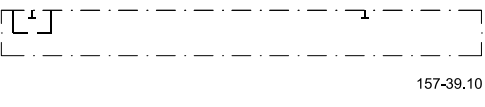
PVS, End Plate

Symbol	Description	Code number
 157-39.10	PVS, without active elements. No connections	157B2000
		157B2020
 157-115.10	PVS, without active elements. Max. intermittend LX pressure 250 bar [3625 psi]	G 1/8 10 mm deep 157B2011
		3/8 in - 24; 0,39 in deep 157B2021
 157-39.10	PVS, without active elements Without connections.	157B2014
		157B2004
 157-115.10	PVS, without active elements LX connections. Max. intermittend LX pressure: 350 bar [5075 psi]	G 1/4 10 mm deep 157B2015
		1/2 in - 20; 0,47 in deep 157b2005

PVAS, Assembly Kit

Code no, 157B...	0	1	2	3	4	5	6	7	8	9	10	11	12
PVB's	8000	8001	8002	8003	8004	8005	8006	8007	8008	8009	8010	8061	8062
PVB + PVPVM	-	8021	8022	8023	8024	8025	8026	8027	8028	8029	8030	8081	8082
Weight kg [lb]	0.1[0.2]	0.15 [0.3]	0.25 [0.6]	0.30 [0.7]	0.40 [0.9]	0.45 [1.0]	0.50 [1.1]	0.60 [1.3]	0.65 [1.4]	0.70 [1.6]	0.80 [1.7]	0.85 [1.8]	0.9 [2.0]

PVAS, Assembly Kit for PVPVM

Description	Code number 157B....									
	1 PVB	2 PVB	3 PVB	4 PVB	5 PVB	6 PVB	7 PVB	8 PVB	9 PVB	10 PVB
Tie bolts and seals	8021	8022	8023	8024	8025	8026	8027	8028	8029	8030

*) for one PVB on PVGI (combination 120 / 32)

PVPX, Electrical LS Unloaded Valve

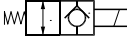
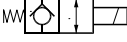
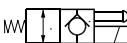
Symbol	Description		Code number
 157-150.10	PVPX, Normally open: LS pressure relieved with no signal to PVPX	12 V	157B4236
		24 V	157B4238
 157-151.10	PVPX, Normally closed: LS pressure relieved with no signal to PVPX	12 V	157B4246
		24 V	157B4248
 157-152.10	PVPX, Normally open with manual override: LS pressure relieved with no signal to PVPX Manual override DE-selects LS-pump	12 V	157B4256
		24 V	157B4258
		26 V	157B4260
-	Plug		157B5601

PVPC, Plug for External Pilot Oil Supply

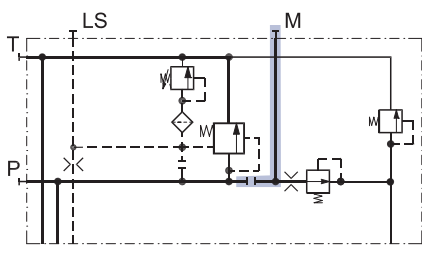
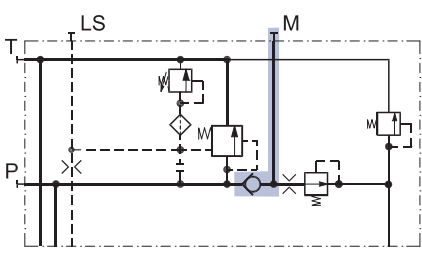
Symbol	Description		Code number
 157-191.10	PVP, Plug without check valve for open or closed centre	G 1/2, 12 mm deep	157B5400
		1/2 in - 20; 0.47 in deep	-
 157-192.10	PVP, Plug with check valve for open centre	G 1/2, 12 mm deep	157B5600
		1/2 in - 20; 0.47 in deep	157B5700

General

The characteristics in this catalogue are typical measured results.
 During measuring a mineral based hydraulic oil with a viscosity of 21 mm²/s [102 SUS] at a temperature of 50°C [122°F] was used.

**PVP,
 Pump Side Module**

**Pressure relief valve characteristic
 in PVP**

The pressure relief valve is set at an oil flow of 15 l/min [4.0 US gal/min].

Setting range:
 30 to 350 bar [435 to 5075 psi]
 (with PVSI end plate) and
 (300 bar [4351 psi] (with PVS end plate)

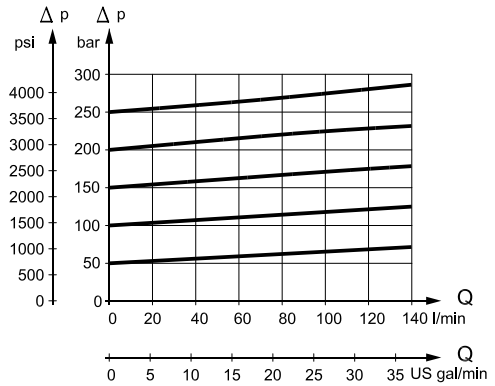

157-83.10

**Neutral flow pressure in PVP,
 open centre**

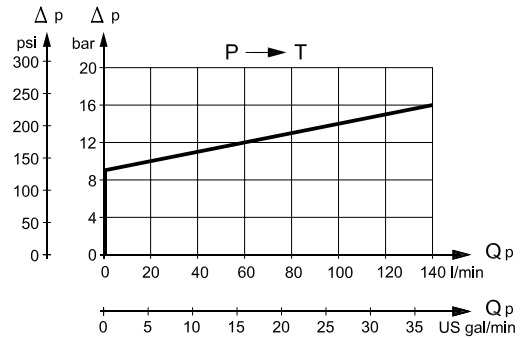

157-184.10

**PVB,
 Basic Module**

Oil flow characteristics

The oil flow for the individual spool depends on

- type of basic module (with/without compensation)
- type of pump (fixed or variable displacement).

Please note:

The letters AA, A, B, etc. denote spool types, see pages 62 to 69. The characteristic below is shown for spool travel in both directions. All other characteristics are shown for spool travel in one direction only.

Pressure-compensated PVB, open or closed centre PVP

The oil flow is dependent on the supplied pump oil flow. The characteristics are plotted for a pump oil flow, Q_P corresponding to the rated max. spool oil flow, Q_N . Increasing the pump oil flow to $1,4 \times Q_N$ will give the same oil flow on the eighth as on the first basic module.

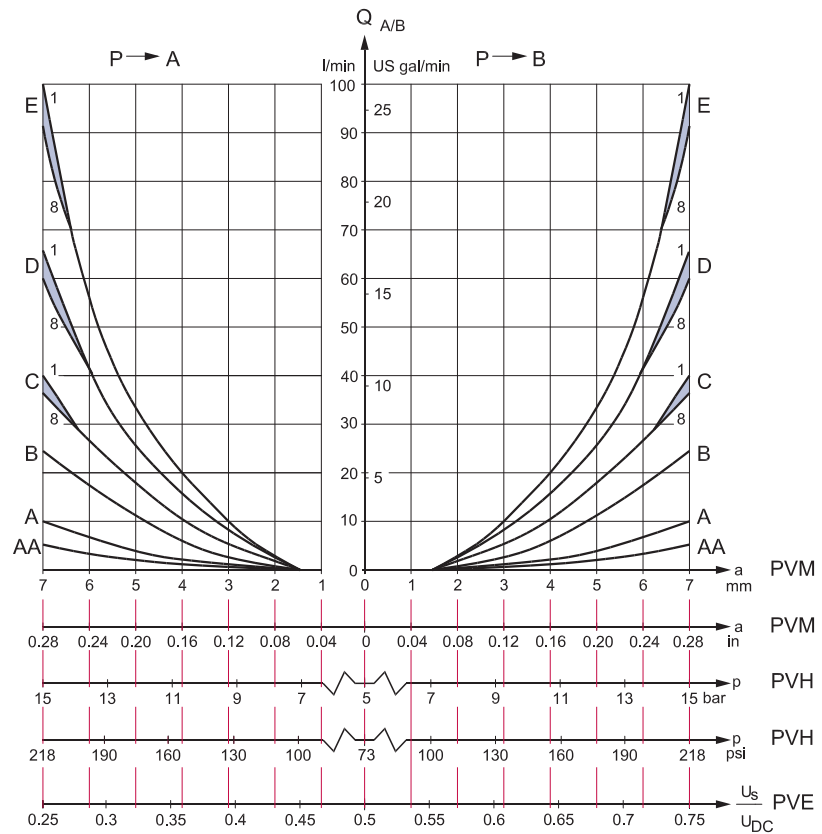

157-61.10

- U_s = Signal voltage
- U_{DC} = Supply voltage
- 1 = First PVB after PVP
- 8 = Eighth PVB after PVP

**PVB,
 Basic Module**

Pressure compensated PVB, open or closed centre PVP
 Linear characteristic

Please note:

For PVB basic modules without pressure compensator the top ends of the characteristics (max. oil flow) are different so they correspond to those of the standard flow control spools, see characteristics for PVB without pressure compensator.

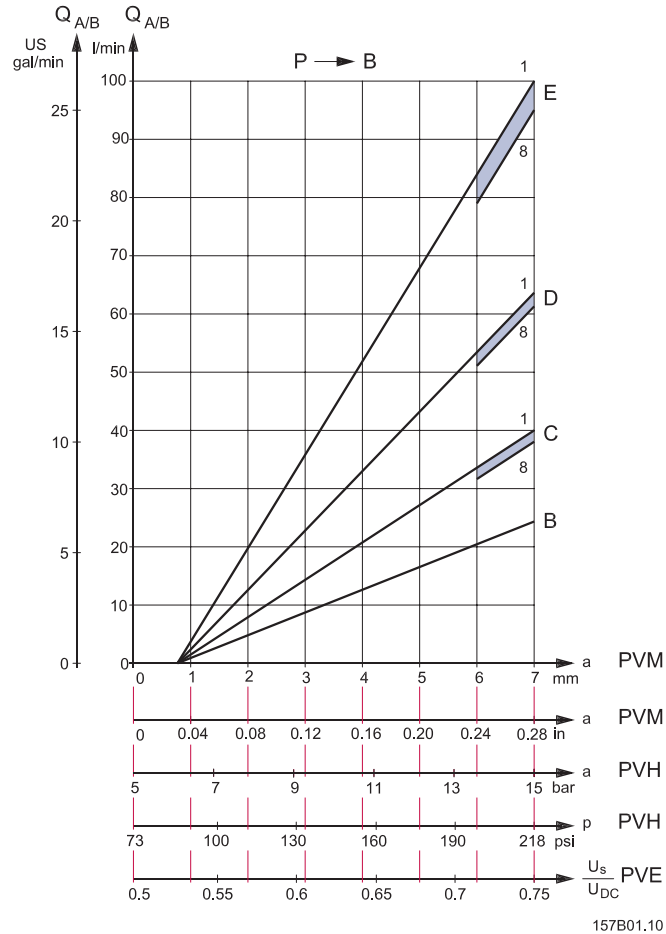

- U_s = Signal voltage
- U_{DC} = Supply voltage
- 1 = First PVB after PVP
- 8 = Eighth PVB after PVP

157B01.10

**PVB,
 Basic Module**

PVB without pressure compensation, open centre PVP

Oil flow as a function of spool travel.

The spool flow is dependent on the supplied oil flow, Q_p . The characteristics apply to supply oil flow of 130 l/min [34.3 US gal/min] with the actuation of one basic module. If several basic modules are activated at the same time, the characteristic depends on the load pressure of the actuated basic modules.

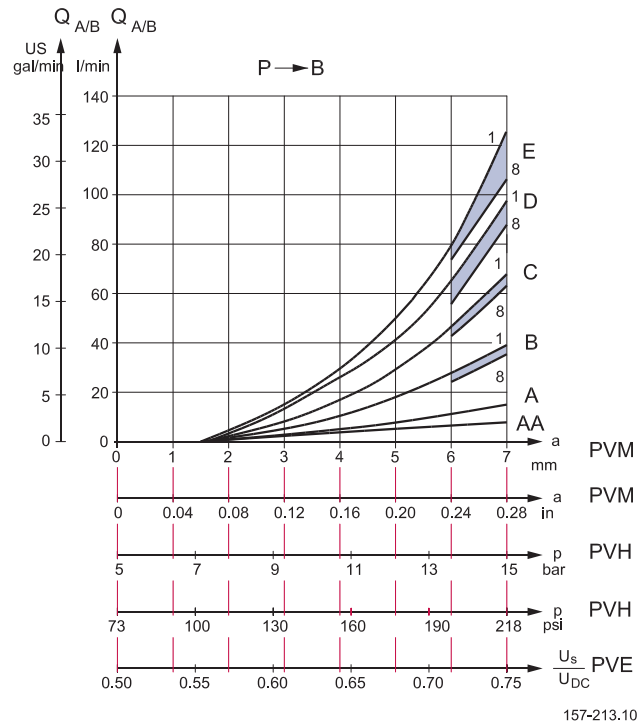

**PVB,
 Basic Module**

PVB without pressure compensation, open centre PVP

Oil flow $Q_{A/B}$ as a function of supplied pump oil flow (Q_p) – curves for fully displaced flow control spools.

The pressure drop of any oil flowing back to tank ($Q_p - Q_{A/B}$) is read on the curve for neutral flow pressure in PVP, [page 36](#).

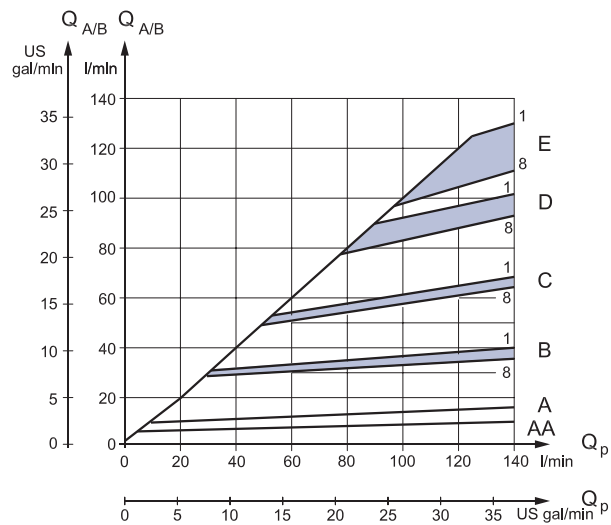

157-212.10

**PVB,
 Basic Module**

PVB without pressure compensation, closed centre PVP

Set pressure difference between pump pressure and LS signal = 10 bar [145 psi].

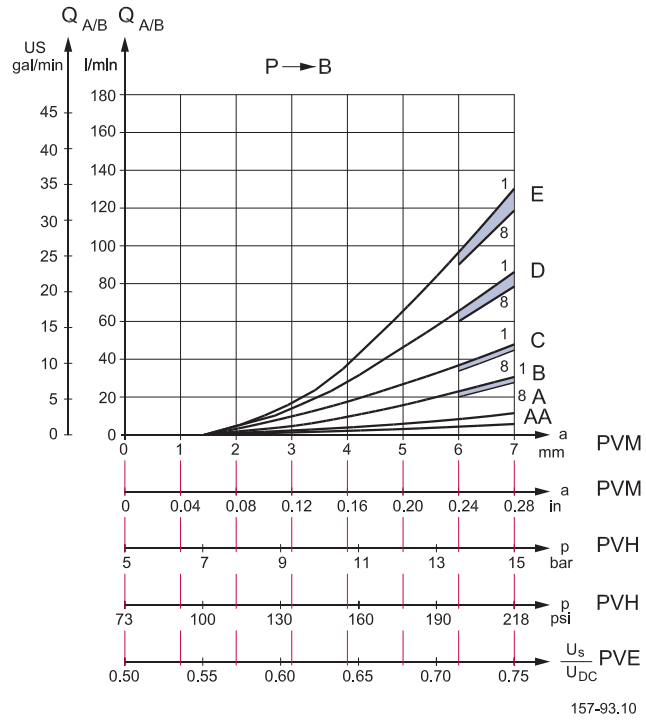

**PVB,
 Basic Module**

PVB without pressure compensation, closed centre PVP

Set pressure difference between pump pressure and LS signal = 20 bar [290 psi].

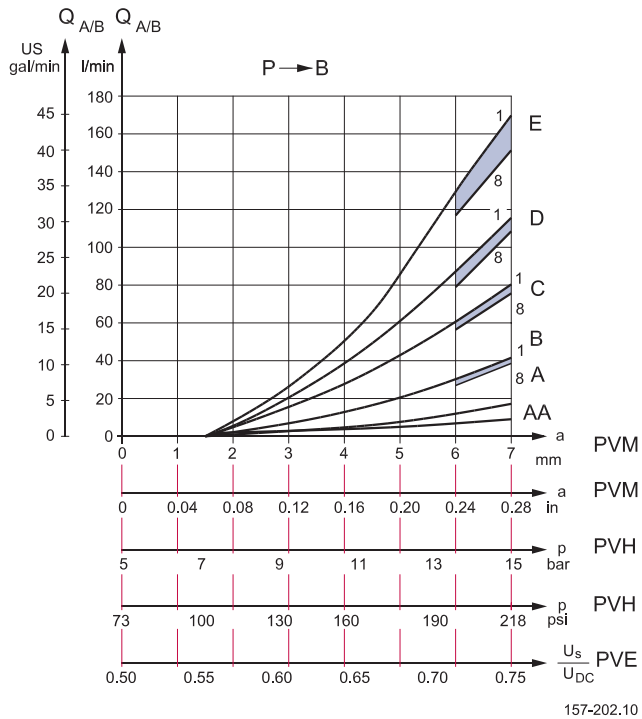

The oil flow is dependent on the pressure difference between the pump pressure and the LS signal. Normally the pressure difference is set at the LS pump regulator.

**PVB,
Basic Module**

**Pressure drop PVB at max. main
spool travel**

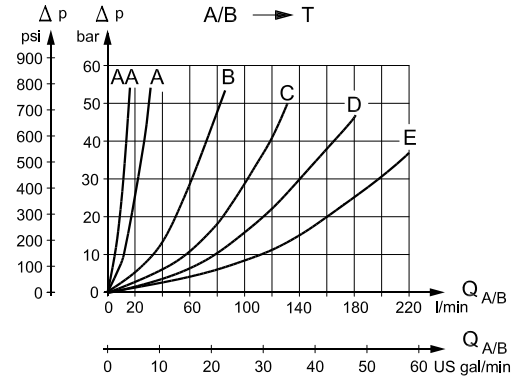

157-97.10

**Pressure drop PVB for open spool in
neutral position**

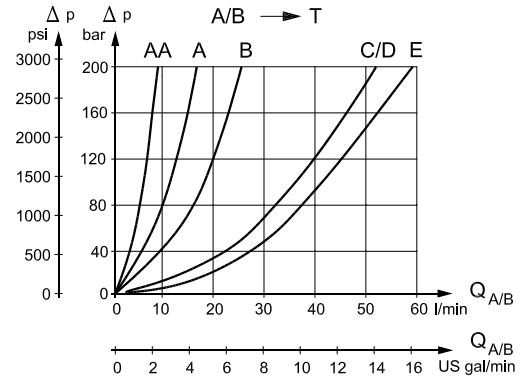

157-203.10

**Load-independent oil flow,
pressure-compensated PVB**

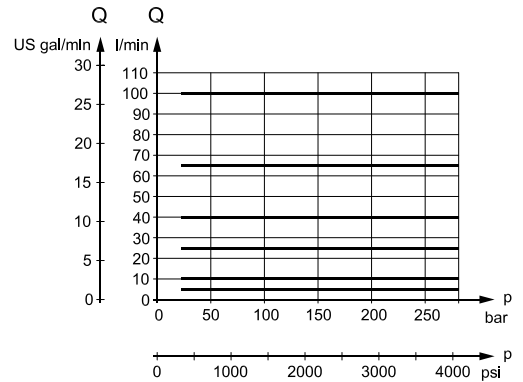

157-89.10

**Oil flow at LS pressure limiting,
pressure-, compensated PVB**

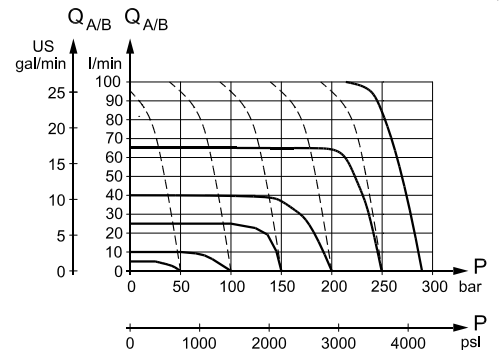

157-87.10

**PVLP,
 Shock and
 Suction Valve**

PVLP, shock valve

PVLP is set at an oil flow of 10 l/min [2.6 US gal/min].

The shock valve PVLP is designed to absorb shock effects. Consequently, it should not be used as a pressure relief valve.

If the working function requires the use of a pressure relief valve, a PVB basic module with built-in LS_{A/B} pressure limiting valve should be used.

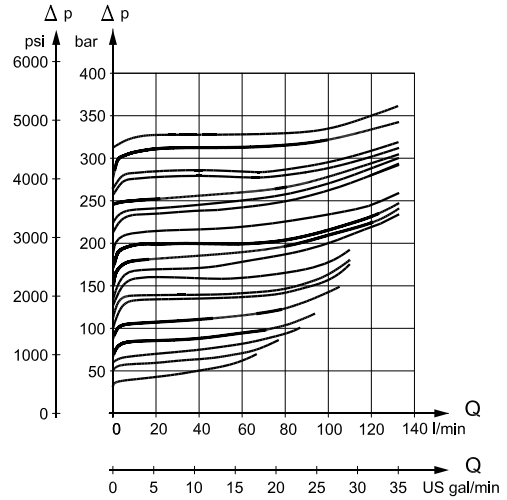

157-312.10

**PVLA,
 Suction Valve**

PVLP/PVLA, suction valve

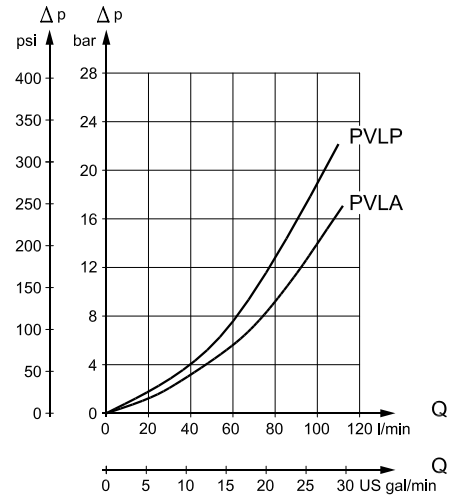

157-313.10

Pressure Control Spools, Characteristics in Extreme Positions

Size A:

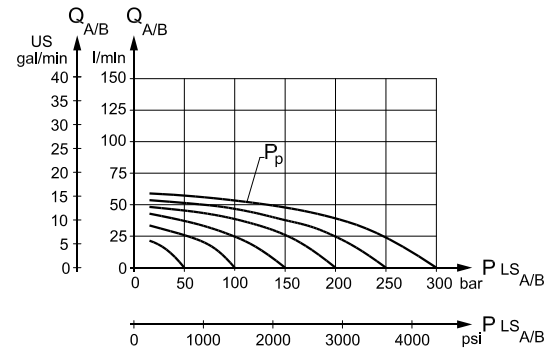

157-157.10

Size B:
1: See example page 46

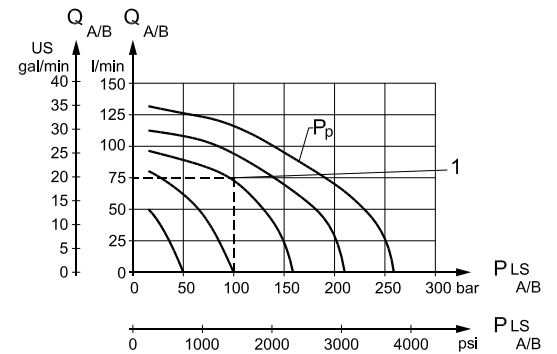

157-158.10

Size C:

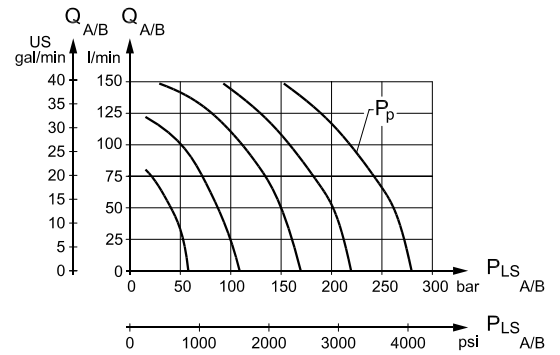

157-159.10

Size D:
2: See example page 46

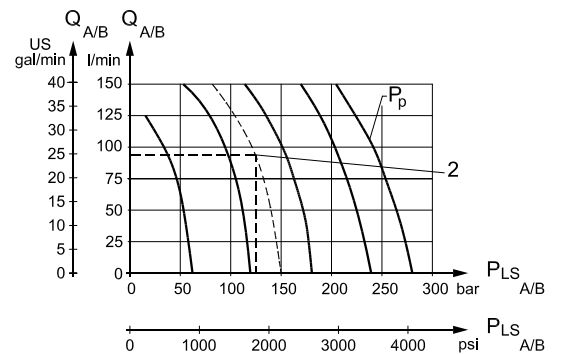

157-160.10

**Pressure Control Spools,
 Characteristics in
 Extreme Positions**

Size E:

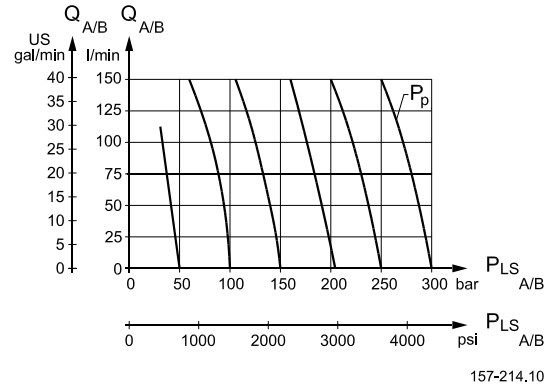

Pressure build-up

Max. oil flow can be reduced by about 50% without limitation of maximum pressure by limiting the main spool travel from 7 mm [0.28 in] to 5.5 mm [0.22 in]

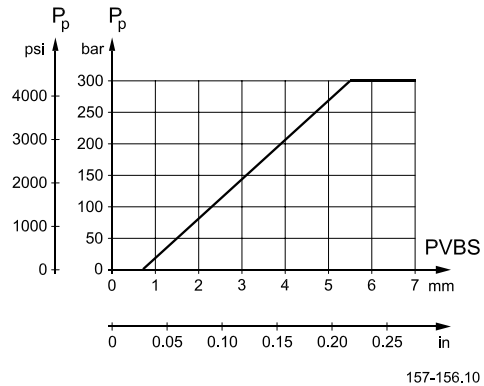

**Examples of How
 To Use the Characteristics
 for Pressure Control
 Spools**

Example of determining the oil flow

- Given:
 - Spool type B
 - Pressure setting P_P : 160 bar [2320 psi]
 - Load pressure, P_{LSA} : 100 bar [1450 psi]
- Result:
 - Oil flow = 75 l/min [19.8 US gal/min] (see page 45, size B).

Example of determining spool size

- Given:
 - Max. oil flow, $Q_{A/B}$: 90 l/min [23.8 US gal/min]
 - Pressure setting P_P : 150 bar [2175 psi]
 - Load pressure, P_{LSA} : 125 bar [1810 psi]
- Result:
 - D spool (see page 45, size D)

Please note:

Normally a smaller spool can be chosen with pressure control. It is our experience that the spool can be one size smaller than with normal flow control.

**Characteristics for Float
 Position Main Spools**

Characteristics; oil flow, spool travel and voltage

The spools have 4,8 mm spool travel in direction A and 8 mm travel in direction B:

- 4.8 mm [0.19 in] spool displacement in direction A gives max. oil flow to port A
- 4.8 mm [0.19 in] spool displacement in direction B gives max. oil flow to port B
- 8 mm [0.32 in] spool displacement in direction B gives completely open float position A/B → T.

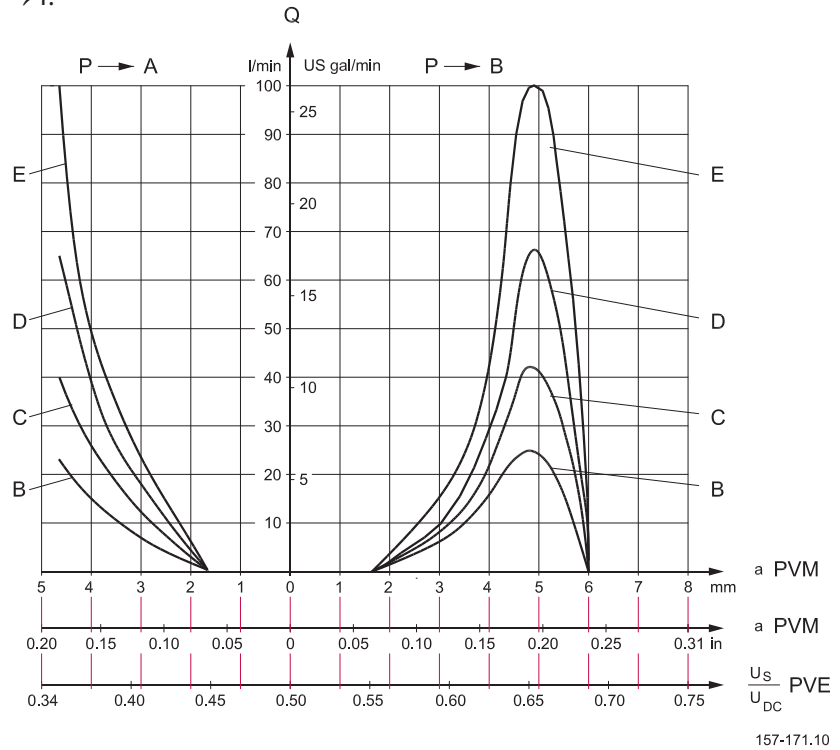

**Pressure drop A/B → T at max. spool travel within the proportional range
 (4.8 mm) [0.19 in]**

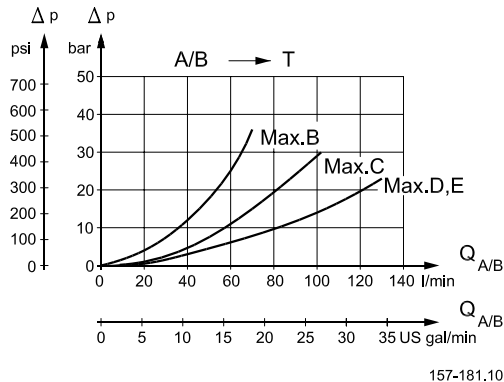

Spools D and E have the same opening area for forward flow and return flow. Spool E can give 100 l/min [26.4 US gal/min] pressure compensated oil flow due to a higher pressure drop across spool E. This occurs during spool actuation only.

**Characteristics for Float
Position Main Spools**

Pressure drop A/B T in float position

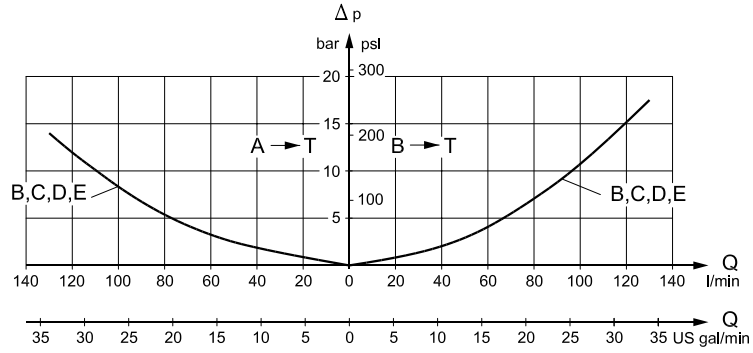

157-172.10

Dimensions

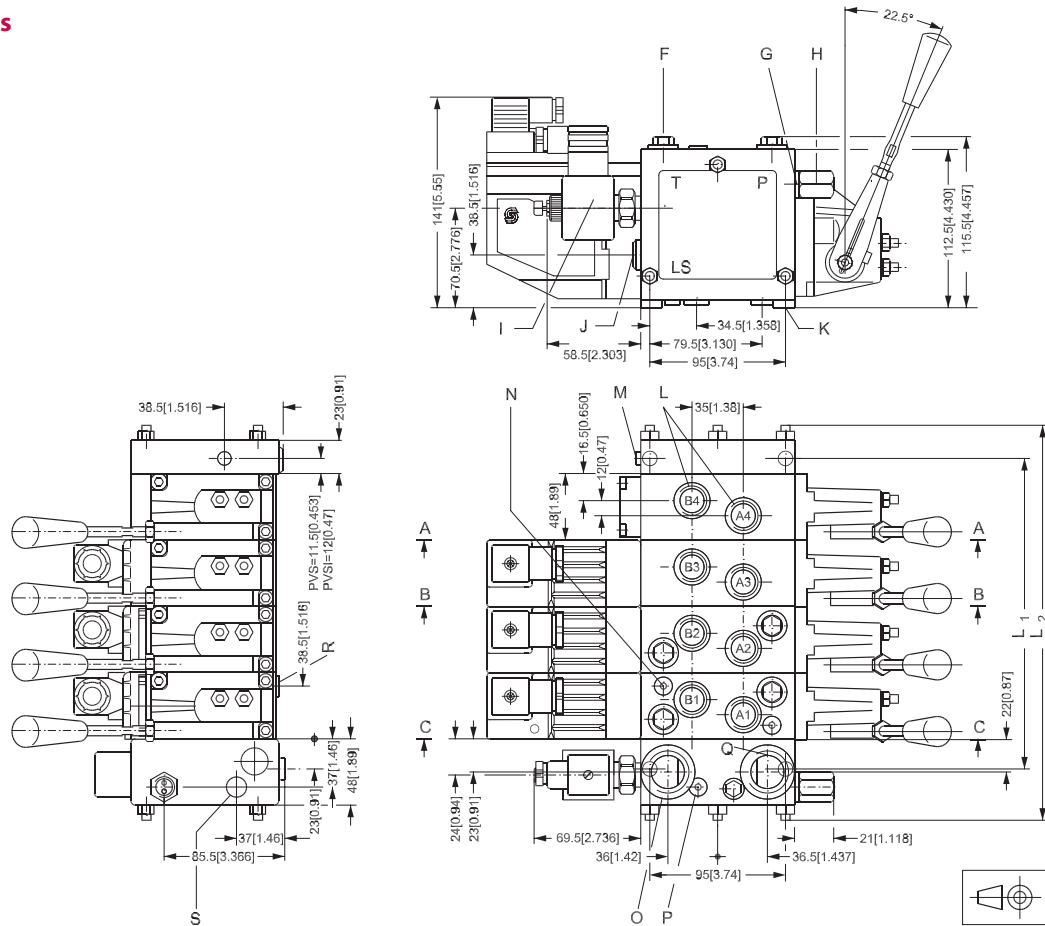

157-52.13

- F : Shock and suction valve, PVLP
- G : Pressure gauge connection; G 1/4, 12 mm deep – [1/2 in-20, 0.47 in deep]
- H : Plug for external pilot oil supply, PVPC; G 1/2, 12 mm deep – [1/2 in-20, 0.47 in deep]
- I : Electrical LS unloading valve, PVPX
- J : LS connection; G 1/4, 12 mm deep – [1/2 in-20, 0.47 in deep]
- K : Fixing holes; M8 × min. 10 – [5/16 in-18, 0.47 in deep]
- L : Port A and B; G 1/2, 14 mm deep – [7/8 in-14, 0.65 in deep]
- M : LX connection: PVS; G 1/8, 10 mm deep – [3/8 in-24, 0.39 in deep]
 PVS; G 1/4, 12 mm [0.47 in] deep – [1/2 in-20, 0.47 in deep]
- N : LS pressure limiting valve
- O : Tank connection; G 3/4, 16 mm deep – [1 1/16 in-12, 0.75 in deep]
- P : Pressure relief valve
- Q : Pump connection; G 1/2, 14 mm deep or G 3/4, 16 mm deep – [7/8 in-14, 0.65 in deep or 1 1/16 in-12, 0.75 in deep]
- R : LS_A and LS_B connections; G 1/4, 12 mm [0.47 in] deep – [1/2 in-20, 0.47 in deep]
- S : Pp, pilot pressure connection G 1/4

PVB		1	2	3	4	5	6	7	8	9	10	11	12
L1	mm	82	130	178	226	274	322	370	418	466	514	562	610
	[in]	[3.23]	[5.12]	[7.01]	[8.90]	[10.79]	[12.68]	[14.57]	[16.46]	[18.35]	[20.24]	[562]	[610]
L2	mm	140	189	238	287	336	385	434	483	527	576	622	670
	[in]	[5.51]	[7.44]	[9.37]	[11.30]	[13.23]	[15.16]	[17.09]	[19.02]	[20.95]	[22.87]	[622]	[670]

Dimensions
 (Continued)

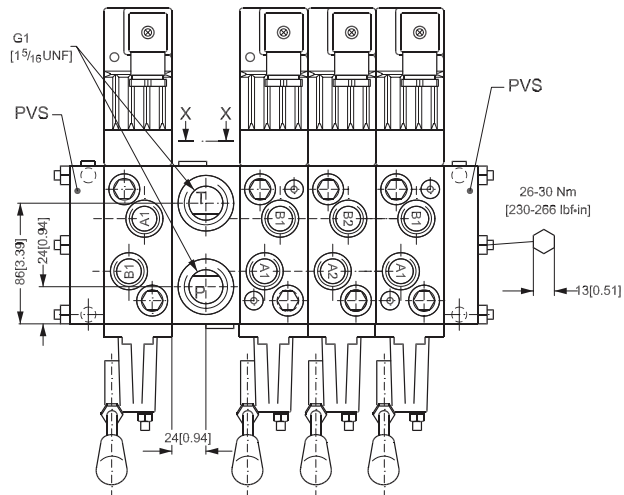
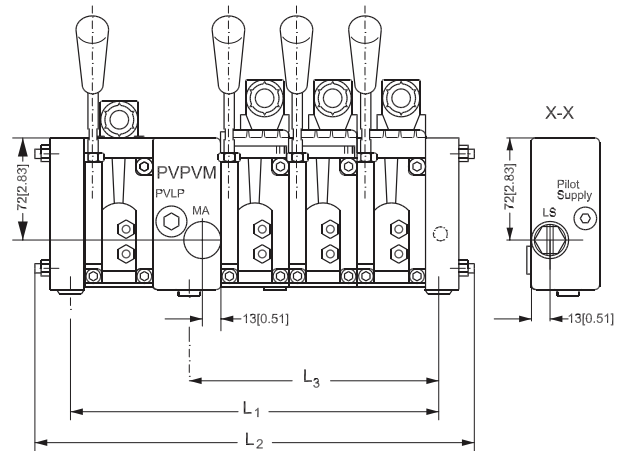

157-314.11

MA og LS: G 1/4
 Work port dimenions, see page 49.

Stay Bolt Set, PVAS for
 PVPVM

In PVG 32 valve groups fitted with PVPV use standard PVAS, 157B8001 - 8010 and 8061 - 8062

Qty., basic Module		1	2	3	4	5	6	7	8	9	10	11	12
L ₁	mm	116	166	214	262	310	358	406	454	502	550	598	646
	[in]	[4.57]	[6.54]	[8.42]	[10.31]	[12.20]	[14.09]	[16.0]	[17.87]	[19.76]	[21.65]	[23.54]	[25.43]
h ₁	mm	165	213	262	311	360	409	458	507	551	600	646	694
	[in]	[6.5]	[8.39]	[10.31]	[12.24]	[14.17]	[16.10]	[18.03]	[19.96]	[21.69]	[23.62]	[25.43]	[27.32]
h ₂	mm	83	131	179	227	275	323	371	419	467	515	563	611
	[in]	[3.27]	[5.16]	[7.05]	[8.94]	[10.83]	[12.72]	[14.61]	[16.50]	[18.38]	[20.28]	[22.17]	[24.06]

**Dimensions
(Continued)**

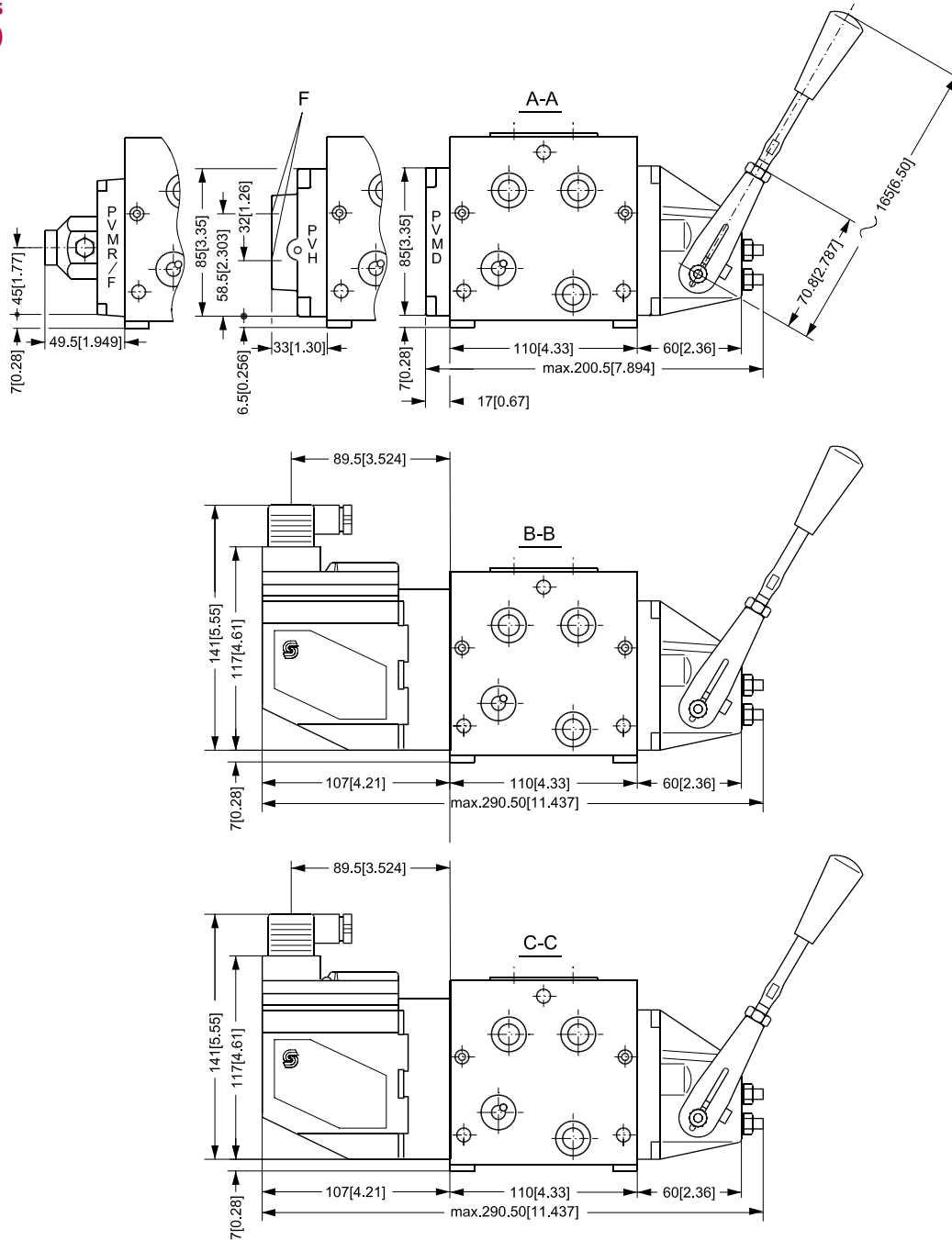

157-53.10

F : G^{1/4}, 12 mm deep [1/2 in - 20, 0.47 in deep]



PVG 32 Proportional Valve
Technical Information
Notes

Notes

Control Lever Positions

Base with an angle of 22.5°
Base with an angle of 37.5°

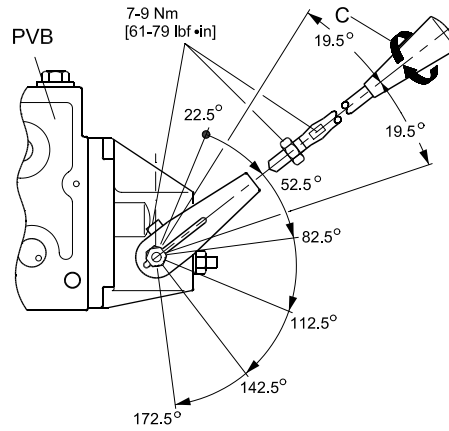

157-75.10

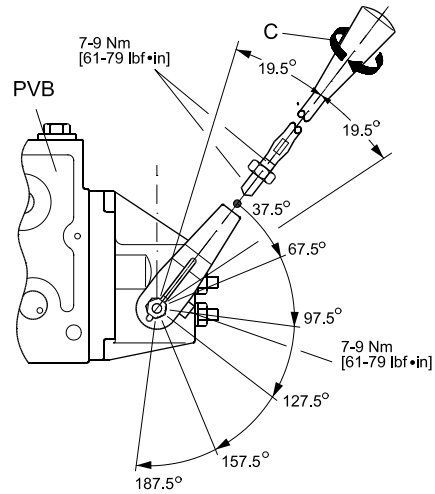

157-64.10

**Manually Actuated
PVG 32 – Fixed
Displacement Pump**

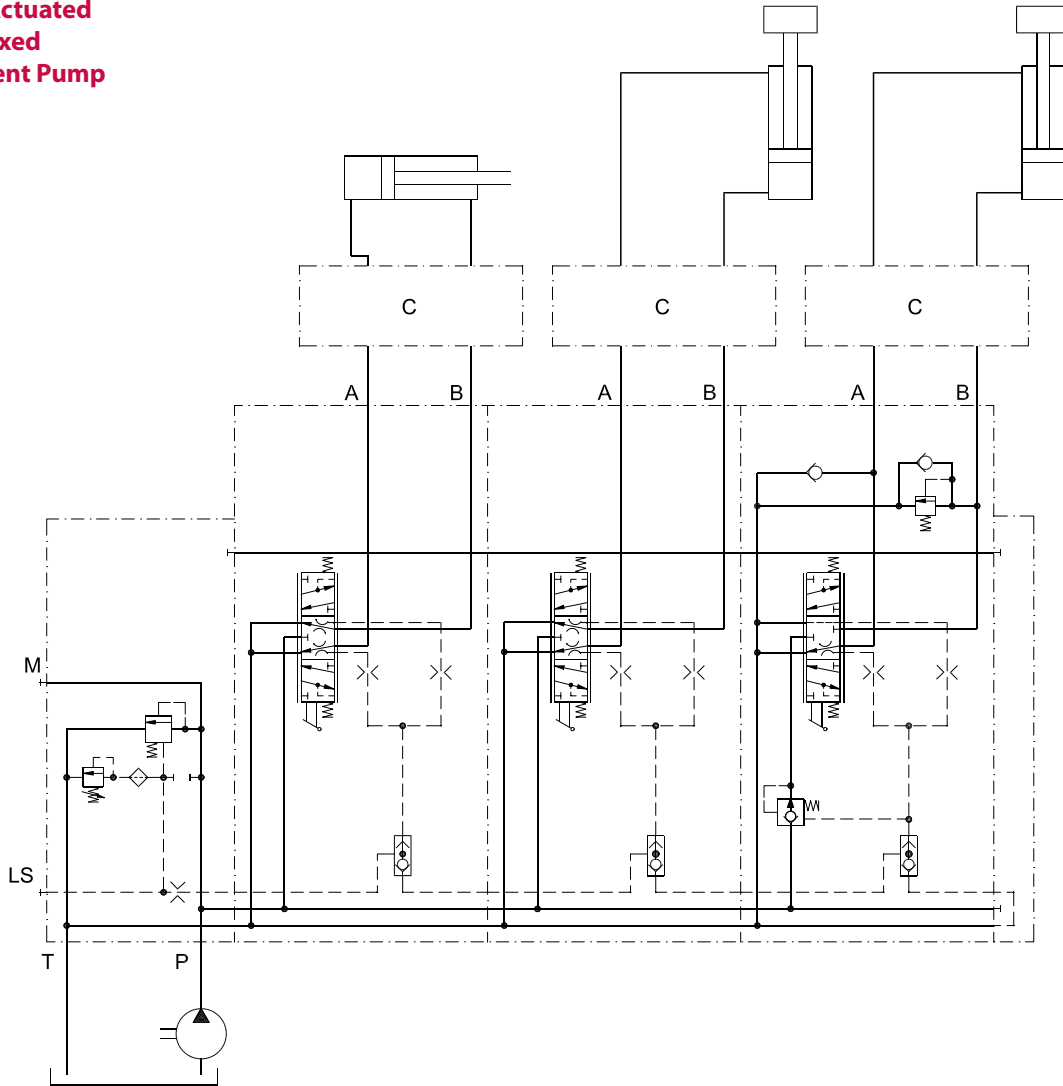

157-55.10

C: Over-centre valve

**Electrically Actuated PVG
32 – Variable
Displacement Pump
(Electrical Actuator,
Shock Valves, etc.)**

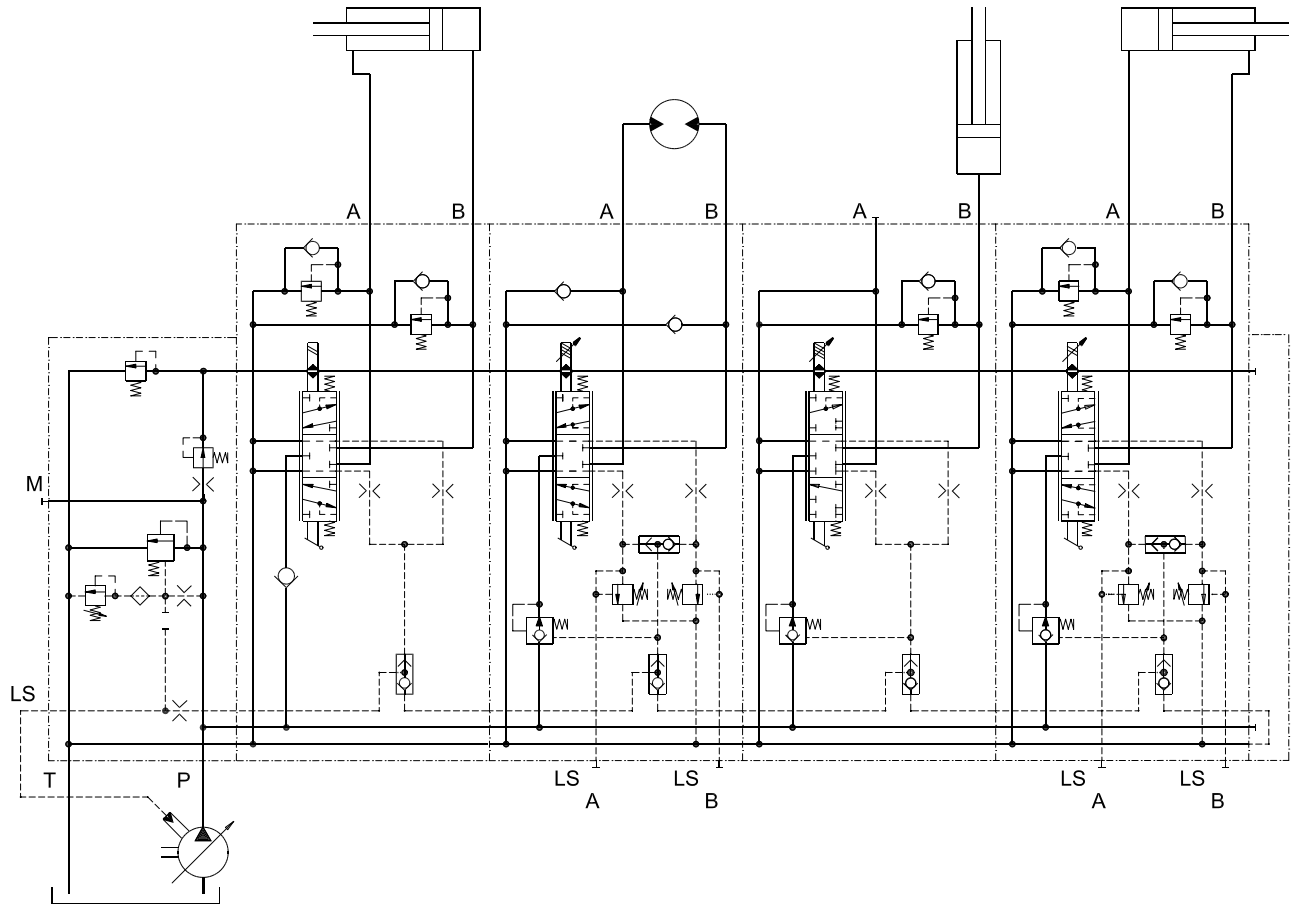

157-56.10

**Electrical Connections,
 General**

The electrical connections to remote control levers, PVE actuators and voltage supply are made using an ordinary terminal strip.

The wiring diagrams below and on [page 56 to 59](#) show only the basic outlines for the electrical connection.

Voltage supply

For a main transformer with stabilised output voltage, the ripple must not exceed 5% of rated voltage.

**Electrical Connection
 Example**

Signal leads must not act as supply leads at the same time unless the distance between the actuator module PVE and terminal board is less than 3 m [3.3 yards] and the lead cross-section is min. 0.75 mm² [AWG 18].

**25 Pin SUB-D connector
 with M3 screws (MIL-DTL-24308)**

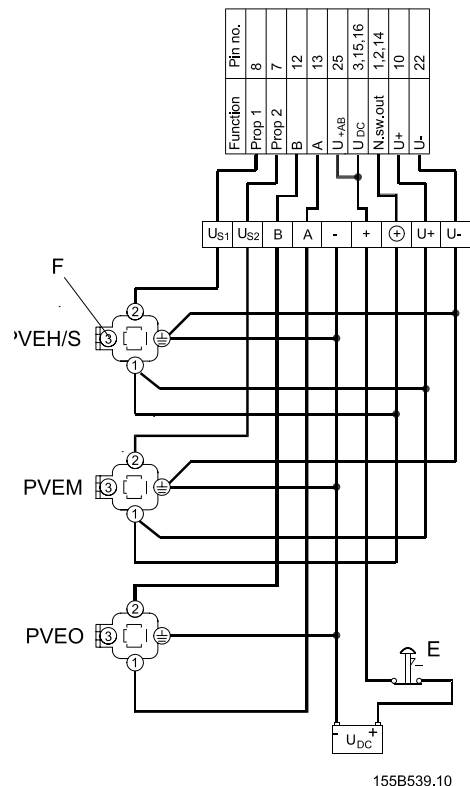
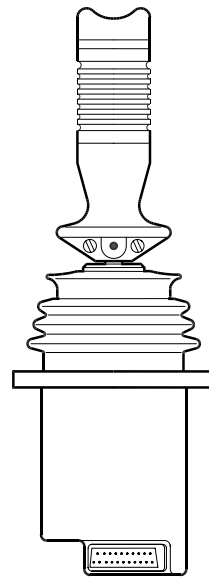
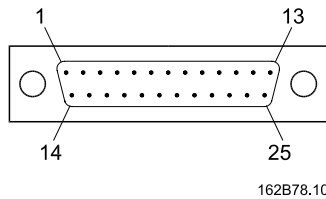

Building in Safety

All makes and all types of directional control valves (incl. proportional valves) can fail. Thus the necessary protection against the serious consequences of function failure should always be built in.

For each application an assessment should be made of the consequences of pressure failure and uncontrolled or blocked movements.

To determine the degree of protection that ought to be built into the system, Sauer-Danfoss makes the following distinctions.

1. Maximum safety demands
2. High safety demands
3. Average safety demands
4. Limited safety demands.

**1.
 Maximum Safety
 Demands**

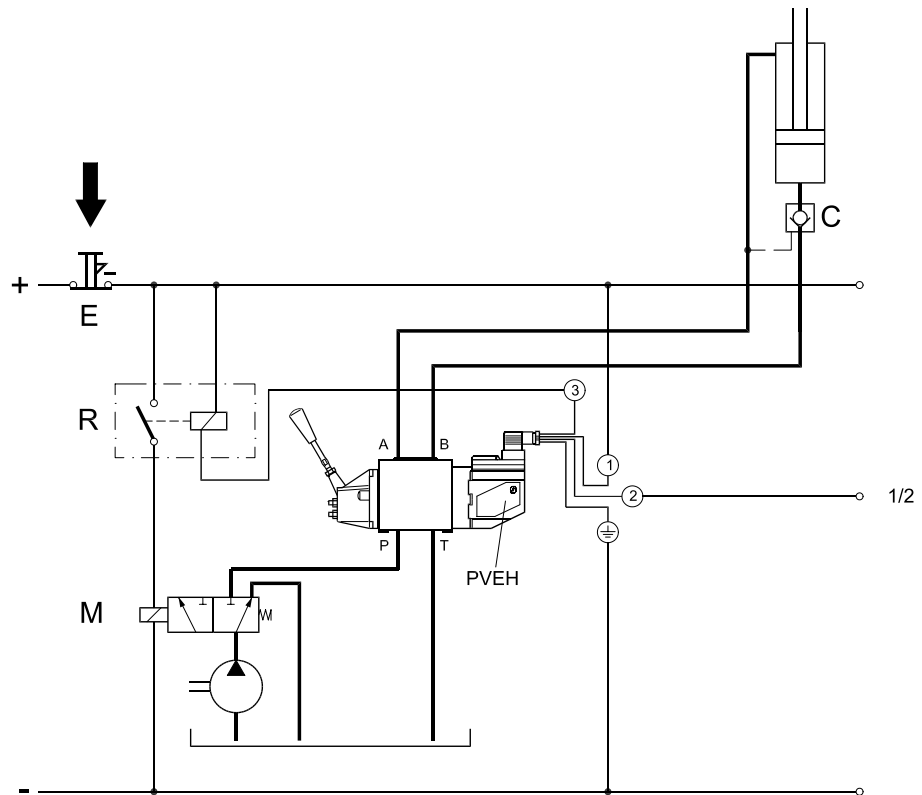

157-100.12

When the fault monitoring system in PVEH is connected, the reaction to electrical and mechanical faults (e.g. a spool seizure) is fast and operator-independent. See page 23 "fault monitoring".

A system can be protected against many electrical, hydraulic and mechanical faults by building in components as shown in the diagram:

- R: Alarm logic EHA (or relay) connected to the fault monitoring system in PVEH
- E: Electrical emergency stop
- M: Solenoid valve
- C: Pilot-operated check valve

The alarm logic EHA cuts off current to the solenoid valve (M) when PVEH monitoring registers a fault. The solenoid valve then leads the oil flow direct from pump to tank. Thus all functions are without operating pressure, i.e. locked in position, because there is no pilot pressure on the pilot operated check valve (C).

Actuation of the emergency switch (E) cuts off current to the proportional valve and the solenoid valve (M). Actuation in this case is manual, but the result is the same as above. Stopping or disconnecting the pump drive motor is another safety measure, if the system reaction time can be accepted.

Note:

The neutral position switch in the remote control units should not be used.
 PVEH with fault monitoring must have a constant voltage supply.

2.
High Safety Demands

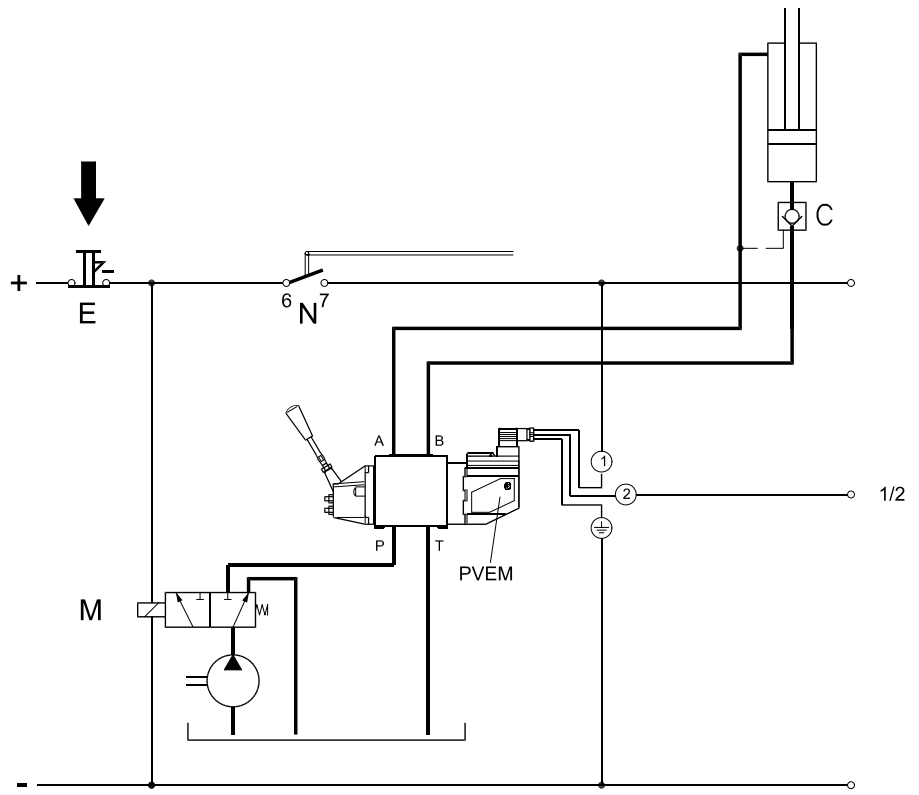

157-101.12

The difference between this safety method and the one previously described (1) is that here there is no built-in automatic fault monitoring and a neutral position switch (N) is connected.

The method still gives a high degree of protection, but requires operator intervention. It is recommended that the neutral position switch be always connected to the electrical system. This then automatically cuts off current to the proportional valve when the remote control unit is in neutral position.

3.
Average Safety Demands

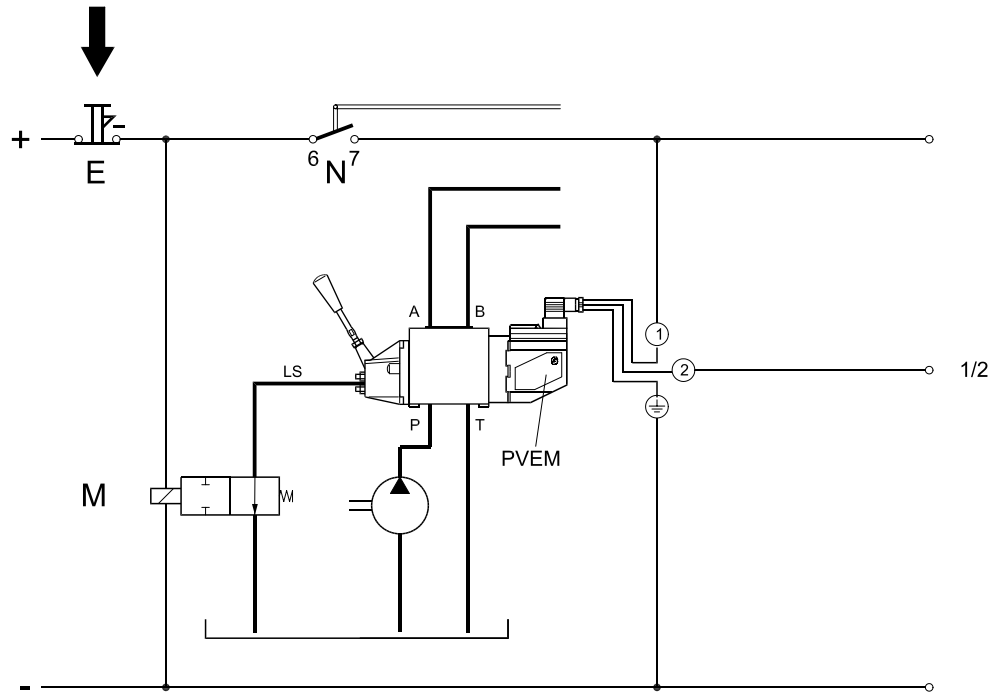

157-102.12

The difference from the previous method is that the LS- signal from the proportional valve is led direct to tank when the emergency switch (E) is actuated. This can be achieved by using the Sauer-Danfoss LS unloading valve PVPX, integrated in the pump side module.

In a system with open centre PVP and a fixed displacement pump, the effect of the PVPX is an almost pressureless system, 8-14 bar [120-200 psi] i.e. all functions requiring a higher operating pressure will not operate, [see page 13](#).

The method can also be used in LS systems with a variable displacement pump and closed centre version proportional valve.
The pressure after LS relief then depends on the pump stand-by pressure.

4.
Limited Safety Demands

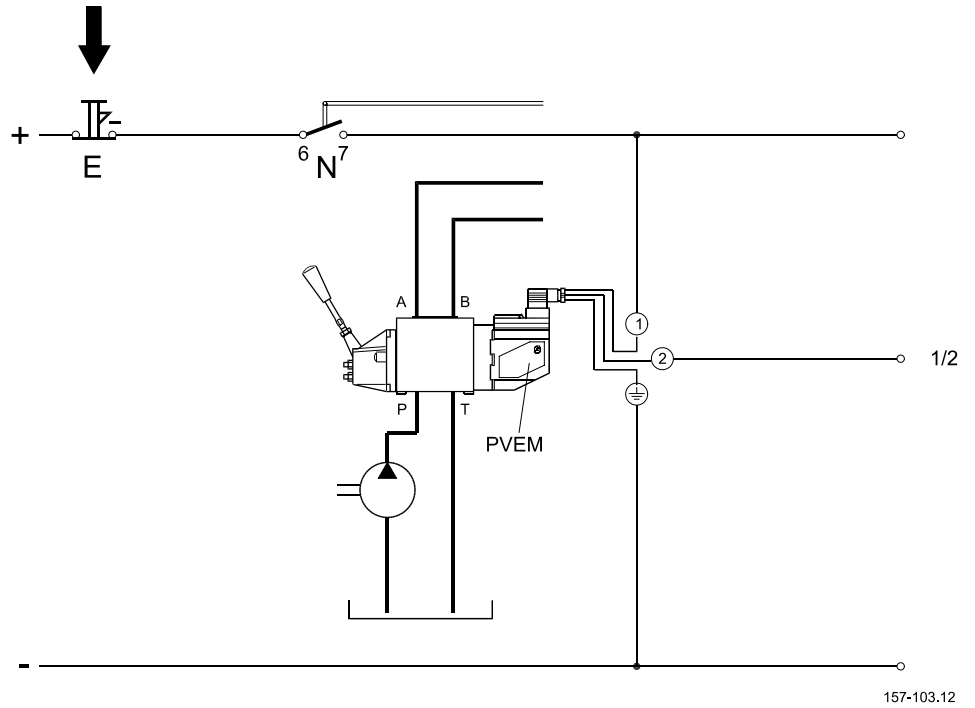

157-103.12

The safety system can consist of an emergency switch (E) and a neutral position switch (N) if protection against electrical failure is the only requirement. Here, there is no protection against hydraulic and mechanical faults (spool seized in an extreme position).

Oil

The main duty of the oil in a hydraulic system is to transfer energy; but it must also lubricate the moving parts in hydraulic components, protect them against corrosion, and transport dirt particles and heat out of the system. It is therefore important to choose the correct oil with the correct additives. This gives normal operation and long working life.

Mineral oil

For systems with PVG 32 valves Sauer-Danfoss recommends the use of mineral-based hydraulic oil containing additives: Type HLP (DIN 51524) or HM (ISO 6743/4).

Non-flammable fluids

Phosphate-esters (HFDR fluids) can be used without special precautions. However, dynamic seals must be replaced with FPM (Viton) seals.

So please contact the Sauer-Danfoss Sales Organization if the PVG 32 valve is to be used with phosphate-esters.

The following fluids should only be used according to agreement with the Sales Organization for Sauer-Danfoss:

- Water-glycol mixtures (HFC fluids)
- Water-oil emulsions (HFB fluids)
- Oil-water emulsions (HFAE fluids)

Biodegradable oils

PVG 32 valves can be used in systems with rapeseed oil. The use of rapeseed oil is conditioned by

- complying with the demands on viscosity, water content, temperature and filtering etc. (see chapters below and technical data [page 14](#)).
- adapting the operating conditions to the directions of the oil supplier.

Before using other biodegradable fluids, please consult the Sauer-Danfoss Organization.

Particle Content, Degree of Contamination

Oil filtration must prevent particle content from exceeding an acceptable level, i.e. an acceptable degree of contamination.

Maximum contamination for PVG 32 is 23/19/16 (see ISO 4406. Calibration in accordance with the ACFTD method).

In our experience a degree of contamination of 23/19/16 can be maintained by using a filter fineness as described in the next section.

Filtration

Effective filtration is the most important precondition in ensuring that a hydraulic system performs reliably and has a long working life. Filter manufacturers issue instructions and recommendations. It is advisable to follow them.

System filters

Where demands on safety and reliability are very high a pressure filter with bypass and indicator is recommended. Experience shows that a 10 µm nominal filter (or finer) or a 20 µm absolute filter (or finer) is suitable.

It is our experience that a return filter is adequate in a purely mechanically operated valve system.

The fineness of a pressure filter must be selected as described by the filter manufacturer so that a particle level of 23/19/16 is not exceeded.

The filter must be fitted with pressure gauge or dirt indicator to make it possible to check the condition of the filter.

In systems with differential cylinders or accumulators the return filter must be sized to suit the max. return oil flow. Pressure filters must be fitted to suit max. pump oil flow.







Internal filters

The filters built into PVG 32 are not intended to filter the system but to protect important components against large particles. Such particles can appear in the system as a result of pump damage, hose fracture, use of quick-couplings, filter damage, starting up, contamination, etc.

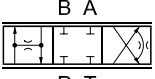
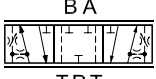
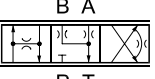

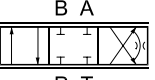

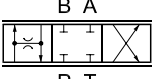
The filter in the electrical actuator PVE protecting the solenoid valves has a mesh of 150 µm.

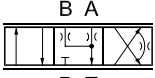
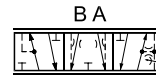
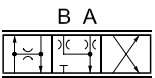
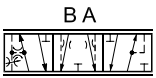
Bursting pressure drop for internal filters is 25 bar [360 psi].

Standard PC Spools

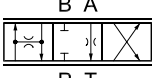
To be used when PVB is with LS _{A/B} shuttle valve						Code number 157B....	To be used when PVB is without LS _{A/B} shuttle valve						
Size							Size						
Press. compensated flow l/min [US gal/min]							ISO symbol	Symbol	Press. compensated flow l/min [US gal/min]				
E 100 [26.4]	D 65 [17.2]	C 40 [10.6]	B 25 [6.6]	A 10 [2.6]	AA 5 [1.3]	AA 5 [1.3]			A 10 [2.6]	B 25 [6.6]	C 40 [10.6]	D 65 [17.2]	E 100 [26.4]
-	7033	7032	7031	7030	7035	 P T 157-143.10	 TPT 157-121.10	7015	7010	7011	7012	7013	-
7134	7133	7132	7131	7130	7135	 P T 157-146.10	 TPT 157-128.10	7115	7110	7111	7112	7113	-
7064	7063	7062	7061	-	-	 P T 157-144.10	 TPT 157-123.10	-	7040	7041	7042	7043	7044
7074	7073	7072	7071	-	-	 P T 157-145.10	 TPT 157-122.10	-	7050	7051	7052	7053	7054
7164	7163	7162	7161	-	-	 P T 157-147.10	 TPT 157-130.10	-	7150	7151	7152	7153	7154
7174	7173	7172	7171	-	-	 P T 157-148.10	 TPT 157-132.10	-	7150	7151	7152	7153	7154

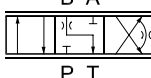
Standard PC Spools

To be used when PVB is with LS _{A/B} shuttle valve						Code number 157B....		To be used when PVB is without LS _{A/B} shuttle valve					
Size						ISO symbol	Symbol	Size					
Press. compensated flow l/min [US gal/min]								Press. compensated flow l/min [US gal/min]					
E 100 [26.4]	D 65 [17.2]	C 40 [10.6]	B 25 [6.6]	A 10 [2.6]	AA 5 [1.3]			AA 5 [1.3]	A 10 [2.6]	B 25 [6.6]	C 40 [10.6]	D 65 [17.2]	E 100 [26.4]
-	7473	7472	7471	7470	-	 P T 157-149.10	 TPT 157-142.10	-	-	-	7452	7453	-
						4-way, 3-position Throttled, A → T neutral position, PC → B							
-	7563	7562	-	-	-	 P T 157-167.10	 TPT 157-188.10	-	-	7541	7542	7543	-
						4-way, 3-position Throttled, B → T neutral position, PC → A							

Standard PC Spools, Hydraulic Actuation

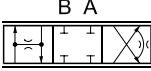
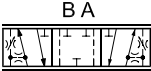
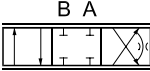
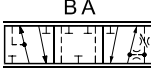
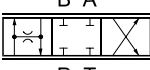
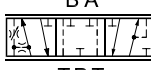
To be used when PVB is with LS _{A/B} shuttle valve						Code number 157B....		To be used when PVB is without LS _{A/B} shuttle valve					
Size						ISO symbol	Symbol	Size					
Press. compensated flow l/min [US gal/min]								Press. compensated flow l/min [US gal/min]					
E	D	C	B	A	AA	ISO symbol	Symbol	AA	A	B	C	D	E
100 [26.4]	65 [17.2]	40 [10.6]	25 [6.6]	10 [2.6]	5 [1.3]			5 [1.3]	10 [2.6]	25 [6.6]	40 [10.6]	65 [17.2]	100 [26.4]
-	-	-	-	-	-	 B A P T 157-143.10	 B A TPT 157-121.10	9015	9010	9011	9012	-	-
-	-	-	-	-	-	 B A P T 157-144.10	 B A TPT 157-123.10	-	-	-	9042	9043	9044
-	-	-	-	-	-	 B A P T 157-145.10	 B A TPT 157-122.10	-	-	-	9052	9053	9054

Standard FC Spools

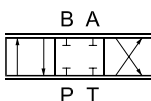
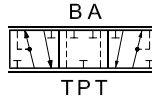
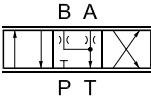
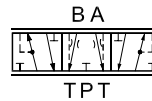
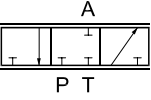
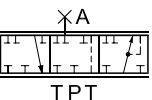
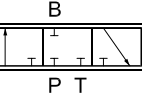
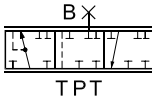
To be used when PVB is with LS _{A/B} shuttle valve							Code number 157B....	To be used when PVB is without LS _{A/B} shuttle valve							
Size								Size							
Press. compensated flow l/min [US gal/min]								ISO symbol	Symbol	Press. compensated flow l/min [US gal/min]					
F 130 [34.3]	E 100 [26.4]	D 65 [17.2]	C 40 [10.6]	B 25 [6.6]	A 10 [2.6]	AA 5 [1.3]	AA 5 [1.3]			A 10 [2.6]	B 25 [6.6]	C 40 [10.6]	D 65 [17.2]	E 100 [26.4]	F 130 [34.3]
7026	7024	7023	7022	7021	7020	7025	  157-02.10 157-26.10 4-way, 3-position Closed neutral position	7005	7000	7001	7002	7003	7004	7006	
7126	7124	7123	7122	7121	7120	7125	  157-03.10 157-27.10 4-way, 3-position Throttled, open neutral position	7105	7100	7101	7102	7103	7104	7106	
-	-	-	-	-	-	-	  157-04.10 157-28.10 4-way, 3-position Closed neutral position, P → A	-	7200	7201	7202	7203	7204	-	
-	-	-	-	-	-	-	  157-05.10 157-29.10 3-way, 3-position Closed neutral position, P → B	-	-	7301	7302	7303	7304	-	

Standard FC Spools

To be used when PVB is with LS _{A/B} shuttle valve							Code number 157B....	To be used when PVB is without LS _{A/B} shuttle valve							
Size								ISO symbol	Symbol	Size					
Press. compensated flow l/min [US gal/min]							AA			A	B	C	D	E	F
F	E	D	C	B	A	AA		5	10						
130	100	65	40	25	10	5	[1.3]	[2.6]	[6.6]	[10.6]	[17.2]	[26.4]	[34.3]		
-	7424	7423	7422	7421	-	-	 157-06.10 157-30.10 4-way, 3-position Throttled, A → T in neutral position	-	-	7401	7402	7403	7404	7406	
-	7524	7523	7522	7521	-	-	 157-07.10 157-31.10 4-way, 3-position Throttled, B → T in neutral position	-	-	7501	7502	7503	7504	-	
-	7624	7623	7622	7621	7620	-	 157-139.10 157-140.10 4-way, 4-position Closed neutral position Float P → B → F	-	-	-	-	-	-	-	

Standard FC Spools, Hydraulic Actuation

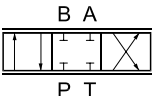
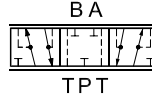
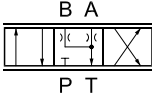
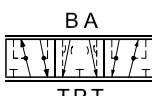
To be used when PVB is with LS _{A/B} shuttle valve						Code number 157B....		To be used when PVB is without LS _{A/B} shuttle valve					
Size						ISO symbol	Symbol	Size					
Press. compensated flow l/min [US gal/min]								Press. compensated flow l/min [US gal/min]					
E 100 [26.4]	D 65 [17.2]	C 40 [10.6]	B 25 [6.6]	A 10 [2.6]	AA 5 [1.3]			AA 5 [1.3]	A 10 [2.6]	B 25 [6.6]	C 40 [10.6]	D 65 [17.2]	E 100 [26.4]
9024	9023	9022	9021	9020	9025	 157-02.10 4-way, 3-position closed neutral position	 157-117.10	9005	9000	9001	9002	9003	9004
9124	9123	9122	9121	9120	9125	 157-03.10 4-way, 3-position Throttled open neutral position	 157-118.10	9005	9000	9001	9002	9003	9004

PVMR, FC Spools for Friction Detent

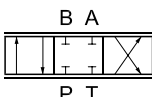
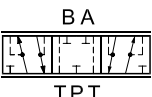
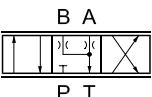
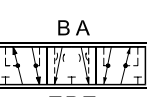
To be used when PVB is with LS _{A/B} shuttle valve						Code number 157B....		To be used when PVB is without LS _{A/B} shuttle valve					
Size						ISO symbol	Symbol	Size					
Press. compensated flow l/min [US gal/min]								Press. compensated flow l/min [US gal/min]					
E 100 [26.4]	D 65 [17.2]	C 40 [10.6]	B 25 [6.6]	A 10 [2.6]	AA 5 [1.3]			AA 5 [1.3]	A 10 [2.6]	B 25 [6.6]	C 40 [10.6]	D 65 [17.2]	E 100 [26.4]
9724	9723	9722	9721	9720	-	 157-02.10 4-way, 3-position closed neutral position	 157-117.10	-	9700	9701	9702	9703	9704
9734	9733	9732	9731	9730	-	 157-03.10 4-way, 3-position Throttled open neutral position	 157-118.10	-	9710	9711	9712	9713	9714

FC Spools for Mechanical Float Position PVMF

To be used when PVB is with LS _{A/B} shuttle valve							Code number 157B....	To be used when PVB is without LS _{A/B} shuttle valve							
Size								ISO symbol	Symbol	Size					
Press. compensated flow l/min [US gal/min]							AA			A	B	C	D	E	F
F	E	D	C	B	A	AA		5	10						
130	100	65	40	25	10	5	[1.3]	[2.6]	[6.6]	[10.6]	[17.2]	[26.4]	[34.3]		
[34.3]	[26.4]	[17.2]	[10.6]	[6.6]	[2.6]	[1.3]									
-	9824	9823	9822	9821	9820	9825	<p>157-09.10</p>	<p>157-454.10</p>	-	-	-	-	-	-	
-	9624	623	9622	9621	-	-	<p>157-139.10</p>	<p>157-140.10</p>	-	-	-	-	-	-	

FC Spools with Linear Flow Characteristic

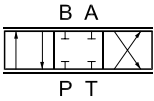
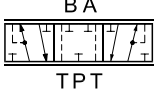
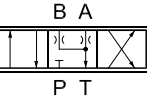
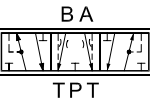
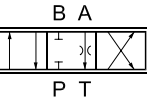
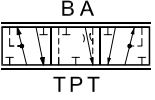
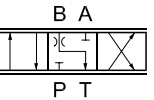
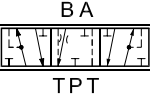
To be used when PVB is with LS _{A/B} shuttle valve							Code number 157B....		To be used when PVB is without LS _{A/B} shuttle valve						
Size							ISO symbol	Symbol	Size						
Press. compensated flow l/min [US gal/min]									Press. compensated flow l/min [US gal/min]						
F	E	D	C	B	A	AA	ISO symbol	Symbol	AA	A	B	C	D	E	F
130 [34.3]	100 [26.4]	65 [17.2]	40 [10.6]	25 [6.6]	10 [2.6]	5 [1.3]			5 [1.3]	10 [2.6]	25 [6.6]	40 [10.6]	65 [17.2]	100 [26.4]	130 [34.3]
-	9774	9773	9772	9771	-	-	 157-02.10	 157-26.10	-	9750	9751	9752	9753	9754	-
-	9784	9783	9782	9781	-	-	 157-03.10	 157-27.10	-	9760	9761	9762	9763	9764	-
-	-	-	-	-	-	-	 157-06.10	 157-30.10	-	-	-	-	-	9794	-
-	-	-	-	-	-	-	 157-07.10	 157-31.10	-	-	-	-	-	9804	-

PVB, basic valves

Code no. 157B....	No facilities for shock valves A and B		Facilities for shock valves A and B	
	G 1/2	7/8 - 14 UNF	G 1/2	7/8 - 14 UNF
Without compensator /check valve	6000	6400	6030	6430
With check valve	6100	6500	6130	6530
With check valve and LS _{A/B} shuttle valve	-	-	6136	6536
With compensator valve	6200	6600	6230	6630
With damped compensator valve	6206	-	6236	-
With compensator valve, LS _{A/B} relief valve and LS _{A/B} shuttle valve	6203	6603	6233	6633
With damped compensator valve, LS _{A/B} relief valve and LS _{A/B} shuttle valve	6208	-	6238	-
Weight kg [lb]	3.1 [6.8]		3.0 [6.6]	

PVPC, plugs

Code no. 157B....	G 1/2	1/2 in - 20	Weight kg [lb]	
External pilot supply	5400	-	0.05	0.1
External pilot supply incl. check valve	5600	5700	0.05	0.1

PVM, mechanical actuation

Standard	157B....	3171** 3172	3191* 3192*	22.5° 37.5°
Standard, with base, without arm and button	157B....	3174 3175	3194* 3195*	37.5° 22.5°
Standard, without base, arm and button	157B....	3173	3193*	-
Weight	kg [lb]	0.4 [0.9]		

* Without stop screws. **Anodized 157B3184

End plate, PVS, PVS1

Code no. 157B....		BSP	SAE	Weight kg [lb]	
PVS, without connections		2000	2020	0.5	1.1
PVS, with LX connection	G 1/8 [3/8 -24 UNF]	2011	2021	0.5	1.1
PVS1, without connections		2014	2004	1.7	3.6
PVS1, with LX connections	G 1/4 [1/2 -20 UNF]	2015	2005	1.7	3.6

PVAS, assembly kit

Code no, 157B...	0	1	2	3	4	5	6	7	8	9	10	11	12
PVB's	8000	8001	8002	8003	8004	8005	8006	8007	8008	8009	8010	8061	8062
PVB + PVPVM	-	8021	8022	8023	8024	8025	8026	8027	8028	8029	8030	8081	8082
Weight kg [lb]	0.1 [0.2]	0.15 [0.3]	0.25 [0.6]	0.30 [0.7]	0.40 [0.9]	0.45 [1.0]	0.50 [1.1]	0.60 [1.3]	0.65 [1.4]	0.70 [1.6]	0.80 [1.7]	0.85 [1.8]	0.9 [2.0]

PVLP, shock/and anti-cavitation valves

Code no. 157B...	2032	2050	2063	2080	2100	2125	2140	2150	2160	2175	2190	2210	2230	2240	2250	2265	2280	2300	2320	2350	
Settings	bar	32	50	63	80	100	125	140	150	160	175	190	210	230	240	250	265	280	300	320	350
	[psij]	460	725	914	1160	1450	1813	2031	2175	2320	2538	2755	3045	3335	3480	3625	3845	4061	4351	4641	5075
Weight	0.05 kg [0.17 lb]																				

PVPV/M, pump side module closed center

Code no. 157B....	With pilot supply for PVE			
	and without PVLP 63		and with PVLP 63	
	G1	1 5/16 - 12UNF	G1	1 5/16 - 12UNF
PVPV	5938	5911	5941	5913
PVPVM	5937	5912	5940	5914
Weight	kg [lb]		3.0 [6.6]	

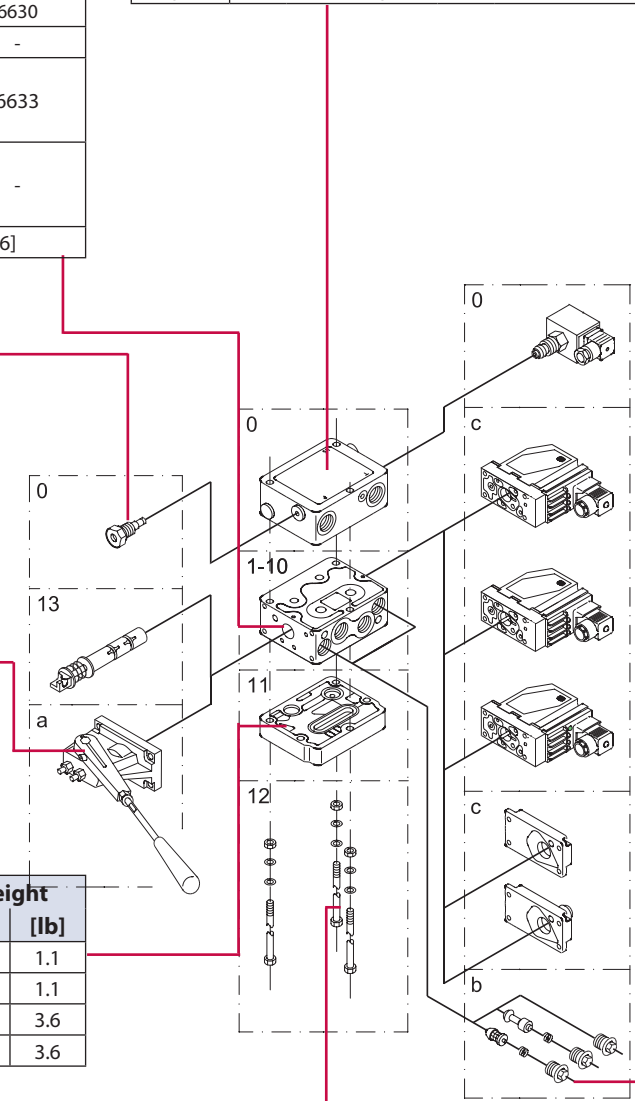

PVP, pump side module

Code no. 157B....		Without pilot supply		With pilot supply			
		for PVE	for PVE with facilit. for PVPX	for PVE	for PVE and facilit. for PVPX	for PVE and pilot oil pressure take-off	for PVH and pilot oil pressure take-off
Open centre	P = G 1/2, T = G 3/4	5000	-	5010	5012	-	-
	P = 7/8 in - 14, T = 1 1/16 in - 12	5200	-	5210	5212	-	-
	P = G 3/4, T = G 3/4	5100	5102	5110	5112	5180	5190
	P = 1 1/16 in - 12, T = 1 1/16 in - 12	5300	-	5310	5312	5380	5390
Closed centre	P = G 1/2, T = G 3/4	5001	-	5011	5013	-	-
	P = 7/8 in - 14, T = 1 1/16 in - 12	5201	-	5211	5213	-	-
	P = G 3/4, T = G 3/4	5101	5103	5111	5113	5181	5191
	P = 1 1/16 in - 12, T = 1 1/16 in - 12	5301	-	5311	5313	5381	5391
Weight	kg [lb]	3.0 [6.6]	3.0 [6.6]	3.0 [6.6]	3.0 [6.6]	3.0 [6.6]	3.0 [6.6]

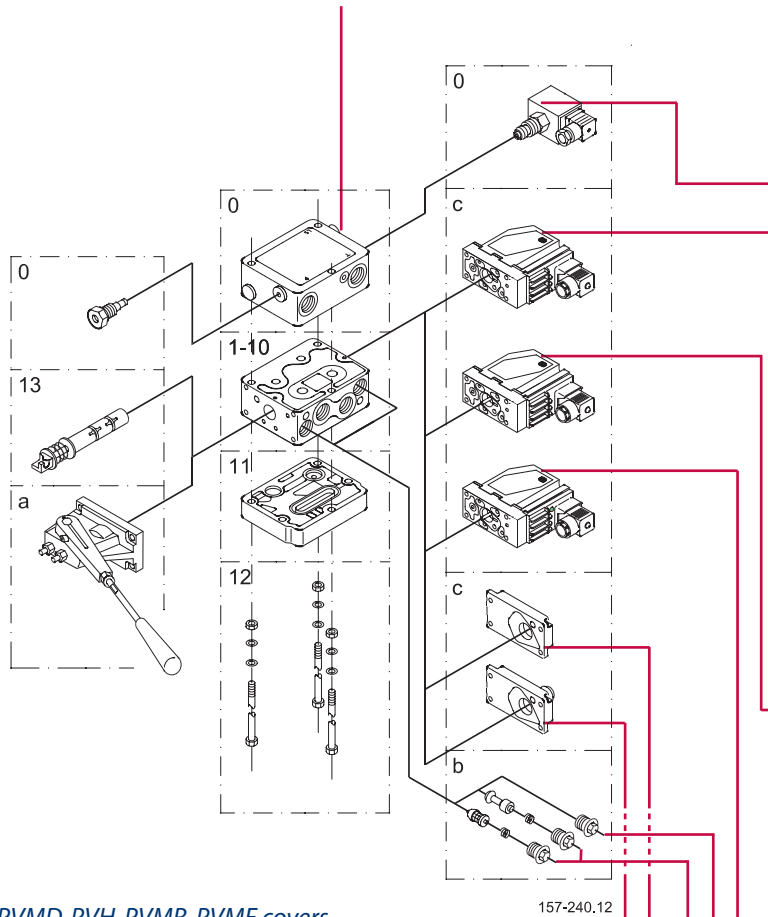

PVPX, electrical LS pressure relief valves

Code no. 157B....	Code No.	Weight	kg	[lb]
Normally open	12 V 4236	0.3	0.7	
	24 V 4238	0.3	0.7	
Normally closed	12 V 4246	0.3	0.7	
	24 V 4248	0.3	0.7	
Normally open with manual override	12 V 4256	0.3	0.7	
	24 V 4258	0.3	0.7	
	26 V 4260	0.3	0.7	
Plug	5601	0.06	0.13	

PVE, electrical actuation

Code no. 157B....		Code No.			Weight
		Hir.	AMP	Deut.	kg [lb]
PVEO, on-off	12 V 4216	4901	4291	0.6 [1.3]	
	24 V 4228	4902	4292	0.6 [1.3]	
PVEO-R, on/off	12 V 4217	4903	-	0.6 [1.3]	
	24 V 4229	4904	-	0.6 [1.3]	
PVEM, prop. medium - Standard	12 V 4116	-	-	0.9 [2.0]	
	24 V 4128	-	-	0.9 [2.0]	
PVEM, prop. medium - Float -> B	12 V 4416	-	-	1.0 [2.2]	
	24 V 4428	-	-	1.0 [2.2]	
PVEA, active fault mon.	-	4734	4792	0.9 [2.0]	
PVEA, passive fault mon.	-	4735	-	0.9 [2.0]	
PVEA-DI, active fault mon.	-	4736	4796	0.9 [2.0]	
PVEA-DI, passive fault mon.	-	4737	-	0.9 [2.0]	
PVEH active fault mon.	4032	4034	4092	1.0 [2.2]	
PVEH passive fault mon.	4033	4035	4093	1.0 [2.2]	
PVEH float -> B, act. fault	4332	-	4392	1.0 [2.2]	
PVEH float -> A, act. fault	-	4338	-	1.0 [2.2]	
PVEH- DI active fault mon.	-	4036	4096	1.0 [2.2]	
PVEH- DI passive fault mon.	-	4037	-	1.0 [2.2]	
PVES, active fault mon.	4832	4834	4892	1.0 [2.2]	
PVES, passive fault mon.	4833	4835	-	1.0 [2.2]	

PVMD, PVH, PVMR, PVMF covers

Code no. 157B....	Code No.	Weight	kg	[lb]
Cover for PVM	0001	0.1	0.2	
Hydraulic actuation PVH G 1/4	0008	0.2	0.4	
Hydraulic actuation PVH 9/16 - 18 UNF	0007	0.9	2.0	
PVMR (frict. detent)	0004	0.3	0.6	
PVMF (mech. float position)	0005	0.3	0.6	

PVLA, anti-cavitation valve

Code no. 157B....	Code No.	Weight	kg	[lb]
Plug A or B	2002	0.04	0.09	
Valve A or B	2001	0.05	0.1	

Order Specification

An order form for Sauer-Danfoss PVG 32 hydraulic valve is shown on the next page. The form can be obtained from the Sauer-Danfoss Sales Organization.

Both the module selection chart on the previous pages and the order form are divided into fields 0, 1-10, 11, 12, 13, a, b, and c.

Each module has its own field:

- 0: - Pump side module PVP
 - Plug for external pilot oil supply PVPC
 - Electrical LS unloading valve PVPX
- 1-10: Basic valves PVB
- 13: Main spool PVBS
- a: Mechanical actuator PVM (or PVE when option mounted)
- c: - Cover for mechanical actuation PVMD
 - Cover for hydraulic actuation PVH
 - Electrical actuators PVE (or PVM when option mounted)
- b: - Shock and suction valve PVLP
 - Suction valve PVLA
- 11: End plate PVS
- 12: Assembly kit PVAS

Please state

- Code numbers of all modules required
- Required setting (P) for pump side module
- Required setting of LS_{A/B} pressure limiting valves, see pressure setting guidance below.

Standard and option assembly

The PVG 32 valve group is assembled the way the module selection chart shows if the code number for PVM is written in field a, and the code number for PVMD, PVE or PVH in field c.

The valve group is assembled so that the mechanical actuator is mounted on the opposite end of the basic module, if the code number for PVM is written in field c of the order form and the code numbers for PVMD, PVE or PVH in field a.

Reordering

The space at the top right-hand corner of the form is for Sauer-Danfoss to fill in. The code number for the whole of the specified valve group (PVG No.) is entered here. In the event of a repeat order all you have to do is enter the number Sauer-Danfoss has given on the initial confirmation of order.

Order Specification

Pressure setting limits

The maximum setting pressure for the pressure limiting valves LS_A or LS_B depends on the chosen pressure setting for shock valve PVLP. The maximum values recommended to avoid interaction can be read in the following table.

The figures in the table have been calculated according to the following expressions:

- PVLP \leq 150 bar: $LS_{A/B} \leq 0.8 \times P_{PVLP}$
- PVLP > 150 bar: $P_{PVLP} - LS_{A/B} \geq 30$ bar.

Max. pressure setting of LS_A and LS_B valves relative to PVLP shock valve

Setting pressure for PVL	bar	32	50	63	80	100	125	140	150	160	175	190	210	230	240	250	265	280	300	320	350
	[psi]	460	725	914	1160	1450	1813	2031	2175	2320	2838	2755	3045	3335	3480	3625	3843	4061	4351	4641	5075
Max. setting pressure for $LS_{A/B}$	bar	-	40	50	64	80	100	112	120	130	145	160	180	200	210	220	235	250	270	290	320
	[psi]	-	580	720	930	1160	1450	1625	1740	1885	2100	2320	2610	2900	3045	3190	3408	3625	3915	4205	4641
Min. setting pressure for $LS_{A/B}$	bar	30																			
	[psi]	435																			

Order Specification

PVG 32
 Specification Sheet

Subsidiary/Dealer		PVG No.	
Customer		Customer No.	
Application		Revision No.	

Function	A-Port	0	157B	157B		B-Port
			p =	bar	157B	
	a 157B	1	157B	157B	13	157B c
	b 157B		LS _A	bar	LS _B bar	157B b
	a 157B	2	157B	157B	13	157B c
	b 157B		LS _A	bar	LS _B bar	157B b
	a 157B	3	157B	157B	13	157B c
	b 157B		LS _A	bar	LS _B bar	157B b
	a 157B	4	157B	157B	13	157B c
	b 157B		LS _A	bar	LS _B bar	157B b
	a 157B	5	157B	157B	13	157B c
	b 157B		LS _A	bar	LS _B bar	157B b
	a 157B	6	157B	157B	13	157B c
	b 157B		LS _A	bar	LS _B bar	157B b
	a 157B	7	157B	157B	13	157B c
	b 157B		LS _A	bar	LS _B bar	157B b
	a 157B	8	157B	157B	13	157B c
	b 157B		LS _A	bar	LS _B bar	157B b
	a 157B	9	157B	157B	13	157B c
	b 157B		LS _A	bar	LS _B bar	157B b
	a 157B	10	157B	157B	13	157B c
	b 157B		LS _A	bar	LS _B bar	157B b
Remarks		11	157B			
		12	157B			

Filled in by	Date
--------------	------

PHYD-PVG32-3

Note:
 Separate specification pads with 50 sheets are available under the literature no. DKMH.PZ.570.D8.02
520L0515.



PVG 32 Proportional Valve
 Technical Information
 Order Specification

Order Specification

PVG 32
 SAE Specification Sheet

Subsidiary/Dealer		PVG No.	
Customer		Customer No.	
Application		Revision No.	

Function	A-Port	0	157B	157B		B-Port
			p =	psi	157B	
	a 157B	1	157B	157B	13	157B c
	b 157B		LS _A	psi	LS _B psi	157B b
	a 157B	2	157B	157B	13	157B c
	b 157B		LS _A	psi	LS _B psi	157B b
	a 157B	3	157B	157B	13	157B c
	b 157B		LS _A	psi	LS _B psi	157B b
	a 157B	4	157B	157B	13	157B c
	b 157B		LS _A	psi	LS _B psi	157B b
	a 157B	5	157B	157B	13	157B c
	b 157B		LS _A	psi	LS _B psi	157B b
	a 157B	6	157B	157B	13	157B c
	b 157B		LS _A	psi	LS _B psi	157B b
	a 157B	7	157B	157B	13	157B c
	b 157B		LS _A	psi	LS _B psi	157B b
	a 157B	8	157B	157B	13	157B c
	b 157B		LS _A	psi	LS _B psi	157B b
	a 157B	9	157B	157B	13	157B c
	b 157B		LS _A	psi	LS _B psi	157B b
	a 157B	10	157B	157B	13	157B c
	b 157B		LS _A	psi	LS _B psi	157B b
Remarks		11	157B			
		12	157B			

Filled in by	Date
--------------	------

PHYD-PVG32-3



PVG 32 Proportional Valve
Technical Information
Notes

Notes



PVG 32 Proportional Valve
Technical Information
Notes

Notes

Our Products

Open circuit axial piston pumps
 Gear pumps and motors
 Fan drive systems
 Closed circuit axial piston pumps and motors
 Bent axis motors
 Hydrostatic transmissions
 Transit mixer drives
 Hydrostatic transaxles
 Electrohydraulics
 Integrated systems
 Microcontrollers and software
 PLUS+1™ GUIDE
 Displays
 Joysticks and control handles
 Sensors
 Orbital motors
 Inverters
 Electrohydraulic power steering
 Hydraulic power steering
 Hydraulic integrated circuits (HIC)
 Cartridge valves
 Directional spool valves
 Proportional valves

Sauer-Danfoss Mobile Power and Control Systems – Market Leaders Worldwide

Sauer-Danfoss is a comprehensive supplier providing complete systems to the global mobile market.

Sauer-Danfoss serves markets such as agriculture, construction, road building, material handling, municipal, forestry, turf care, and many others.

We offer our customers optimum solutions for their needs and develop new products and systems in close cooperation and partnership with them.

Sauer-Danfoss specializes in integrating a full range of system components to provide vehicle designers with the most advanced total system design.

Sauer-Danfoss provides comprehensive worldwide service for its products through an extensive network of Global Service Partners strategically located in all parts of the world.

Local address:

Sauer-Danfoss (US) Company
 2800 East 13th Street
 Ames, IA 50010, USA
 Phone: +1 515 239-6000
 Fax: +1 515 239 6618

Sauer-Danfoss GmbH & Co. OHG
 Postfach 2460, D-24531 Neumünster
 Krokamp 35, D-24539 Neumünster, Germany
 Phone: +49 4321 871-0
 Fax: +49 4321 871 122

Sauer-Danfoss ApS
 DK-6430 Nordborg, Denmark
 Phone: +45 7488 4444
 Fax: +45 7488 4400

Sauer-Danfoss-Daikin LTD
 Sannomiya Grand Bldg. 8F
 2-2-21 Isogami-dori, Chuo-ku
 Kobe, Hyogo 651-0086, Japan
 Phone: +81 78 231 5001
 Fax: +81 78 231 5004